

DVD DIGITAL THEATER SYSTEM

TH-M606/TH-M603

Consists of XV-THM606, SP-PWM606, SP-THM606F, SP-THM606C and SP-THM606S/

Consists of XV-THM603, SP-PWM603, SP-THM606F, SP-THM606C and SP-THM606S

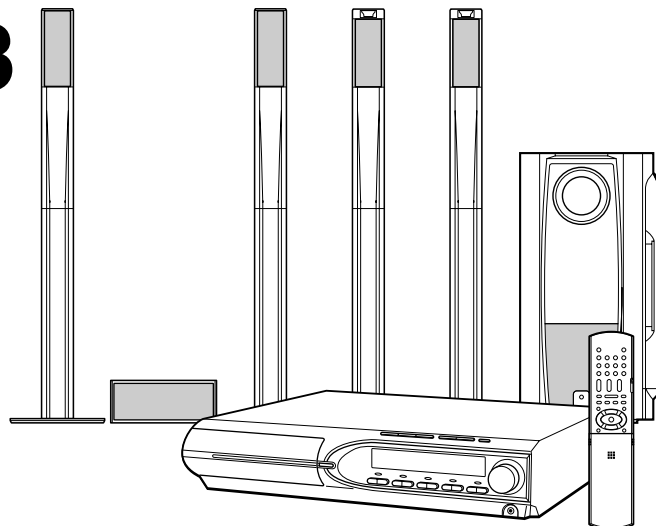

The figure is for the TH-M606.

TH-M505/TH-M501

Consists of XV-THM505, SP-PWM505, SP-THM505F, SP-THM505C and SP-THM505S/

Consists of XV-THM501, SP-PWM501, SP-THM303F, SP-THM303C and SP-THM303S

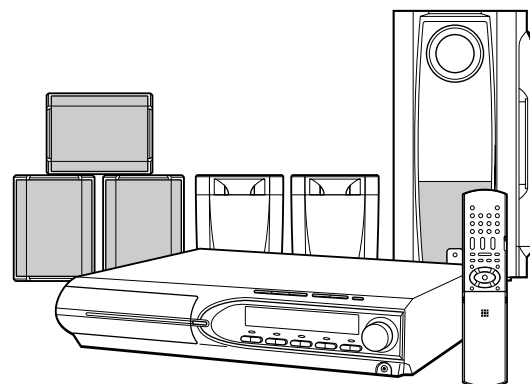

The figure is for the TH-M505.

TH-M303/TH-M301

Consists of XV-THM303, SP-PWM303, SP-THM303F, SP-THM303C and SP-THM303S/

Consists of XV-THM301, SP-PWM301, SP-THM303F, SP-THM303C and SP-THM303S

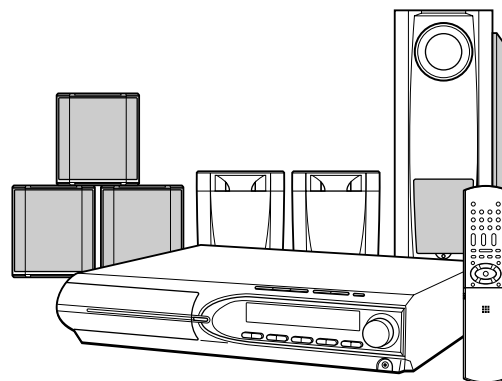

INSTRUCTIONS

For Customer Use:

Enter below the Model No. and Serial No. which are located either on the rear, bottom or side of the cabinet. Retain this information for future reference.

Model No. _____

Serial No. _____

Warnings, Cautions and Others

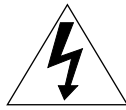
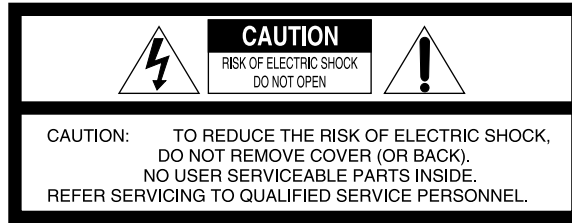

The lightning flash with arrowhead symbol, within an equilateral triangle is intended to alert the user to the presence of uninsulated "dangerous voltage" within the product's enclosure that may be of sufficient magnitude to constitute a risk of electric shock to persons.



The exclamation point within an equilateral triangle is intended to alert the user to the presence of important operating and maintenance (servicing) instructions in the literature accompanying the appliance.

IMPORTANT FOR LASER PRODUCTS

1. CLASS 1 LASER PRODUCT
2. **CAUTION:** Do not open the top cover. There are no user serviceable parts inside the unit; leave all servicing to qualified service personnel.
3. **CAUTION:** Visible and invisible laser radiation when open and interlock failed or defeated. Avoid direct exposure to beam.
4. REPRODUCTION OF LABEL: CAUTION LABEL, PLACED INSIDE THE UNIT.

| | | | |
|---|--|---|--|
| CAUTION : Visible and invisible laser radiation when open and interlock failed or defeated. AVOID DIRECT EXPOSURE TO BEAM. (e) | ADVARSEL : Synlig og usynlig laserstråling når maskinen er åben eller interlocken fejler. Undgå direkte eksponering til stråling. (d) | WARNING : Synlig och osynlig laserstråling när den öppnas och spärren är urkopplad. Betrakta ej strålen. (s) | VARO : Avattaessa ja suojaelukitus ohitettuna tai viallisena olet alttiina näkyvälle ja näkymättömälle lasersäteilylle. Vältä säteen kohdistumista suoraan itseesi. (f) |
|---|--|---|--|

CAUTION

To reduce the risk of electrical shocks, fire, etc.:

1. Do not remove screws, covers or cabinet.
2. Do not expose this appliance to rain or moisture.

CAUTION – button!

**(XV-THM606/ XV-THM603/ XV-THM505/
XV-THM501/ XV-THM303/ XV-THM301)**

Disconnect the mains plug to shut the power off completely (the STANDBY lamp goes off).

The  button in any position does not disconnect the mains line.

- When the system is on standby, the STANDBY lamp lights red.
- When the system is turned on, the STANDBY lamp goes off. The power can be remote controlled.

CAUTION

**(SP-PWM606/ SP-PWM603/ SP-PWM505/
SP-PWM501/ SP-PWM303/ SP-PWM301)**

The power supply to the subwoofer is linked to the center unit. The POWER ON lamp on the subwoofer lights green when the power is turned on.

WARNING: TO REDUCE THE RISK OF FIRE OR ELECTRIC SHOCK, DO NOT EXPOSE THIS APPLIANCE TO RAIN OR MOISTURE.

For U.S.A.

This equipment has been tested and found to comply with the limits for a Class B digital device, pursuant to part 15 of the FCC Rules. These limits are designed to provide reasonable protection against harmful interference in a residential installation.

This equipment generates, uses and can radiate radio frequency energy and, if not installed and used in accordance with the instructions, may cause harmful interference to radio communications. However, there is no guarantee that interference will not occur in a particular installation. If this equipment does cause harmful interference to radio or television reception, which can be determined by turning the equipment off and on, the user is encouraged to try to correct the interference by one or more of the following measures:

Reorient or relocate the receiving antenna.

Increase the separation between the equipment and receiver.

Connect the equipment into an outlet on a circuit different from that to which the receiver is connected.

Consult the dealer or an experienced radio/TV technician for help.

For Canada

CAUTION: TO PREVENT ELECTRIC SHOCK, MATCH WIDE BLADE OF PLUG TO WIDE SLOT, FULLY INSERT.

For Canada

THIS DIGITAL APPARATUS DOES NOT EXCEED THE CLASS B LIMITS FOR RADIO NOISE EMISSIONS FROM DIGITAL APPARATUS AS SET OUT IN THE INTERFERENCE-CAUSING EQUIPMENT STANDARD ENTITLED "DIGITAL APPARATUS," ICES-003 OF THE DEPARTMENT OF COMMUNICATIONS.

Note to CATV system installer:

This reminder is provided to call the CATV system installer's attention to Section 820-40 of the NEC which provides guidelines for proper grounding and, in particular, specifies that the cable ground shall be connected to the grounding system of the building, as close to the point of cable entry as practical.



TH-M606: 48.8 kg/108 lbs
TH-M603: 42.1 kg/93 lbs
TH-M505: 32.0 kg/71 lbs
TH-M501: 31.7 kg/70 lbs
TH-M303: 26.2 kg/58 lbs
TH-M301: 26.2 kg/58 lbs

CAUTION!

To avoid personal injury or accidentally dropping the unit, have two persons unpack, carry, and install the unit.

Table of contents

Introduction 2

| | |
|----------------------------|---|
| Notes on handling | 2 |
| Supplied accessories | 2 |

About discs 3

| | |
|---------------------------|---|
| Playable disc types | 3 |
|---------------------------|---|

Description of parts and controls ... 5

Connections 8

| | |
|---|----|
| Connecting the FM and AM antennas | 8 |
| Assembling the front and surround speakers | 9 |
| Connecting the satellite (front, center, surround) speakers | 10 |
| Speaker layout | 14 |
| Connecting a TV | 14 |
| Connecting the powered subwoofer | 15 |
| Connecting to an analog component | 15 |
| Connecting to a digital component | 15 |
| Connecting the power cord | 15 |

Operating external components with the remote control 16

| | |
|---|----|
| Operating the TV | 16 |
| Operating the DBS tuner or CATV converter | 16 |
| Operating the VCR | 17 |

Basic operations 18

| | |
|---|----|
| Turning the system on/off | 18 |
| Selecting the source to play | 19 |
| Adjusting the volume [VOLUME] | 19 |
| Listening with headphones (not supplied) | 19 |
| Turning off the sound temporarily [MUTING] | 19 |
| Adjusting the brightness of the indications [DIMMER] | 19 |
| Sleep Timer [SLEEP] | 20 |
| Adjusting the output level of the subwoofer and center/surround speakers [SUBWFR, CENTER, SURR L/R] | 20 |
| Adjusting the treble sound [TREBLE] | 20 |
| Changing the scan mode | 20 |
| Optimizing the speaker settings [Smart Surround Setup] | 21 |

Playback 22

| | |
|---|----|
| Basic playback | 22 |
| One Touch Replay | 24 |
| Fast-forward/fast-reverse search | 24 |
| Skip to the beginning of a desired selection | 24 |
| Locating a desired title/group using number buttons | 25 |
| Playing back a bonus group | 25 |

Advanced operations 26

| | |
|---|----|
| Using the surround mode | 26 |
| Using the on-screen bar | 27 |
| Playing from a specified position on a disc | 29 |
| Using the file control display | 30 |
| Resume Playback | 31 |
| Selecting a view angle | 31 |
| Selecting the subtitle | 31 |
| Selecting the audio | 32 |
| Special picture playback | 32 |
| Program Playback | 34 |
| Random Playback | 35 |
| Repeat Playback | 35 |
| Tray lock | 36 |
| Sound and other settings | 37 |

Setting DVD preferences 38

| | |
|-----------------------------|----|
| Using the setup menus | 38 |
| Menu description | 38 |

Tuner operations 42

| | |
|--|----|
| Manual tuning | 42 |
| Preset tuning | 43 |
| Selecting the FM reception mode | 43 |
| Reducing the noise of AM broadcast | 43 |

AV COMPU LINK remote control system 44

References 45

| | |
|-----------------------|----|
| Maintenance | 45 |
| Troubleshooting | 45 |
| Specifications | 46 |

Introduction

Notes on handling

■ Important cautions

Installation of the system

- Select a place which is level, dry and neither too hot nor too cold; between 5°C and 35°C (41°F and 95°F).
- Leave sufficient distance between the system and the TV.
- Do not use the system in a place subject to vibration.

Power cord

- Do not handle the power cord with wet hands!
- A small amount of power is always consumed while the power cord is connected to the wall outlet (center unit only).
- When unplugging the power cord from the wall outlet, always pull on the plug, not the power cord.

To prevent malfunctions of the system

- There are no user-serviceable parts inside. If anything goes wrong, unplug the power cord and consult your dealer.
- Do not insert any metallic object into the system.
- Do not use any non-standard shape disc (like a heart, flower or credit card, etc.) available on the market, because it may damage the system.
- Do not use a disc with tape, stickers, or paste on it, because it may damage the system.

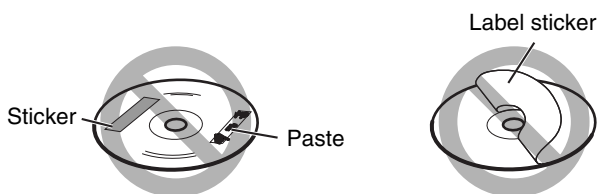

Note about copyright laws

Check the copyright laws in your country before recording from the discs. Recording of copyrighted material may infringe copyright laws.

Note about copyguard system

The discs are protected by copyguard system. When you connect the system to your VCR directly, the copyguard system activates and the picture may not be played back correctly.

■ Safety precautions

Avoid moisture, water and dust

Do not place the system in moist or dusty places.

Avoid high temperatures

Do not expose the system to direct sunlight and do not place it near a heating device.

When you are away

When away on travel or for other reasons for an extended period of time, disconnect the power cord plug from the wall outlet.

Do not block the vents

Blocking the vents may damage the system.

Care of the cabinet

When cleaning the system, use a soft cloth and follow the relevant instructions on the use of chemically-coated cloths. Do not use benzene, thinner or other organic solvents including disinfectants. These may cause deformation or discoloring.

If water gets inside the system

Turn the system off and disconnect the power cord plug from the wall outlet, then call the store where you made your purchase. Using the system in this condition may cause fire or electrical shock.

Supplied accessories

Check to be sure you have all of the supplied accessories.

The number in parentheses is the quantity of the pieces supplied. If anything is missing, contact your dealer immediately.

- Remote control (1)
- Batteries (2)
- FM antenna (1)
- AM loop antenna (1)
- Power cord (1)
- System cord (1)
- Composite video cord (1)
- Speaker cords (TH-M606/TH-M603/TH-M505 only)
For satellite (front left/right) and center speakers (3)
For satellite speakers (surround left/right) (2)
- Screws (with washer) (TH-M606/TH-M603 only)
M5 x 20 mm (13/16 inch):
For satellite speakers (8)

About discs

Playable disc types

This system has been designed to play back the following discs: DVD VIDEO, DVD AUDIO, Video CD (VCD), Super Video CD (SVCD), Audio CD (CD), CD-R and CD-RW.

- This system accommodates the NTSC system, and also can play discs recorded with PAL system. Note that the PAL video signal on a disc is converted to an NTSC signal and output.
- This system can also play MP3, WMA, JPEG and MPEG4 files recorded on CD-Rs and CD-RWs. (☞ pg. 22)
- This system can also play finalized DVD-R/-RWs recorded in DVD VIDEO format. However, some discs may not be played because of their disc characteristics or recording conditions.

Discs you can play:

| | |
|---|--|
| DVD VIDEO  | CD  |
| DVD AUDIO  | CD-R  |
| VCD  Video CD | CD-RW  |
| SVCD   | |

DVD Logo is a trademark of DVD Format/Logo Licensing Corporation.

Region code of DVD VIDEO

DVD VIDEO players and DVD VIDEO discs have their own Region Code numbers. This system can play back DVD VIDEO discs whose Region Code numbers include the system's Region Code, which is indicated on the rear panel.

Example of playable DVD:



If a DVD with an improper Region Code number is loaded, "REGION CODE ERROR!" appears on the TV screen and playback cannot start.

- The following discs cannot be played back: DVD-ROM, DVD-RAM, SACD, CD-ROM, CD-I (CD-I Ready), Photo CD, etc.
Playing back these discs will generate noise and damage the speakers.
- **On some DVD VIDEOS, DVD AUDIOS, VCDs or SVCDs, their actual operation may be different from what is explained in this manual. This is due to the disc programming and disc structure, not a malfunction of this system.**

Notes on CD-R and CD-RW

- User-edited CD-Rs (Recordable) and CD-RWs (Rewritable) can be played back only if they are already "finalized".
- This system can play CD-Rs or CD-RWs recorded on a personal computer if they have been recorded in the audio CD format. This system can also play CD-Rs or CD-RWs if MP3, WMA, JPEG or MPEG4 files are recorded on them.
However, some discs may not be played back because of their disc characteristics, recording conditions, or damage or stain on them.
Especially, the configuration and characteristics of an MP3, WMA, JPEG or MPEG4 disc are determined by the writing (encoding) software and hardware used for recording. Therefore, due to the software and hardware used, the following symptoms may occur:
 - Some discs may not be played back.
 - Some tracks on an MP3 or WMA disc may be skipped or may not be played back normally.
 - Some files on a JPEG or MPEG4 disc may be played back distortedly.
- Before playing back CD-Rs or CD-RWs, read their instructions or cautions carefully.
- CD-RWs may require a longer readout time. This is caused by the fact that the reflectance of CD-RWs is lower than that of regular CDs.

About discs

Notes on MP3/WMA/JPEG/MPEG4 discs

- MP3/WMA/JPEG/MPEG4 discs (either CD-R or CD-RW) require a longer readout time. (It differs due to the complexity of the directory/file configuration.)
- When making an MP3/WMA/JPEG/MPEG4 disc, select ISO 9660 Level 1 or Level 2 for the disc format.
- This system supports “multi-session” discs (up to 20 sessions).
- This system cannot play “packet write” discs.
- The system can only play MP3/WMA/JPEG/MPEG4 files with the following file extensions;
MP3: “.MP3”, “.Mp3”, “.mp3” and “.mp3”
WMA: “.wma”, “.WMA” and any uppercase and lowercase combination (such as “.Wma”)
JPEG: “.jpg”, “.jpeg”, “.JPG”, “.JPEG” and any uppercase and lowercase combination (such as “.Jpg”)
MPEG4: “.asf”, “.ASF” and any uppercase and lowercase combination (such as “.Asf”)
- If different type of files (audio (MP3/WMA), still picture (JPEG), and video (MPEG4) files) are recorded on a disc, set the FILE TYPE setting in the PICTURE menu to the appropriate setting for the data to be read. (☞ pg. 39)
- The system recognizes up to 150 tracks (files) per group, 99 groups per disc, and the total number of the tracks (files) that the system can play is 1000. For example, if you set FILE TYPE to AUDIO (☞ pg. 39) and play a disc that contains 500 MP3 tracks, 200 JPEG files, and 600 WMA tracks, the system can play 500 MP3 tracks and the first 500 of 600 WMA tracks.
- Some MP3/WMA/JPEG/MPEG4 discs may not be played back normally because of their disc characteristics or recording conditions.

Notes on MP3/WMA discs only

- The system supports MP3 files recorded with a bit rate of 32 – 320 kbps and a sampling frequency of 16 kHz, 22.05 kHz, 24 kHz*, 32 kHz, 44.1 kHz, or 48 kHz.
- If the tag information (album name, artist, and track title, etc.) is recorded on a disc, it appears in the file control display on the TV screen. (☞ pg. 30)
- We recommend to record each piece of material (song) at a sample rate of 44.1 kHz and at a data transfer rate of 128 (96*) kbps.
- Some tracks may be skipped or may not be played back normally.
* For WMA only

Notes on JPEG discs only

- We recommend to record a file at 640 x 480 resolution. (If a file has been recorded at a resolution of more than 640 x 480, it will take a longer time to be displayed.)
- This system can only play baseline JPEG files.
- Some files on a JPEG disc may be played back distortedly.

Notes on MPEG4 disc only

- The system supports the types of simple profile as MPEG4 files (MPEG4 SP).
- The system supports MPEG4 files recorded with the maximum bit rate of 384 kbps and an audio codec of G.726. (To play the MPEG4 file, it is required that G.726 formatted audio data is contained in that file.)
- The maximum size of the played picture is at a 352 x 288 pixel resolution (CIF).
- Some files may be skipped or may not be played normally.

This product incorporates copyright protection technology that is protected by method claims of certain U.S. patents and other intellectual property rights owned by Macrovision Corporation and other rights owners. Use of this copyright protection technology must be authorized by Macrovision Corporation, and is intended for home and other limited viewing uses only unless otherwise authorized by Macrovision Corporation. Reverse engineering or disassembly is prohibited.

“CONSUMERS SHOULD NOTE THAT NOT ALL HIGH DEFINITION TELEVISION SETS ARE FULLY COMPATIBLE WITH THIS PRODUCT AND MAY CAUSE ARTIFACTS TO BE DISPLAYED IN THE PICTURE. IN CASE OF 525 OR 625 PROGRESSIVE SCAN PICTURE PROBLEMS, IT IS RECOMMENDED THAT THE USER SWITCH THE CONNECTION TO THE ‘STANDARD DEFINITION’ OUTPUT. IF THERE ARE QUESTIONS REGARDING OUR TV SET COMPATIBILITY WITH THIS MODEL 525p AND 625p DVD PLAYER, PLEASE CONTACT OUR CUSTOMER SERVICE CENTER.”

USE OF THIS PRODUCT IN ANY MANNER THAT COMPLIES WITH THE MPEG-4 VISUAL STANDARD IS PROHIBITED, EXCEPT FOR USE BY A CONSUMER ENGAGING IN PERSONAL AND NON-COMMERCIAL ACTIVITIES.

Description of parts and controls

The illustrations of the center unit and the subwoofer used in this manual are of TH-M606 unless otherwise noted.

Front panel (center unit)

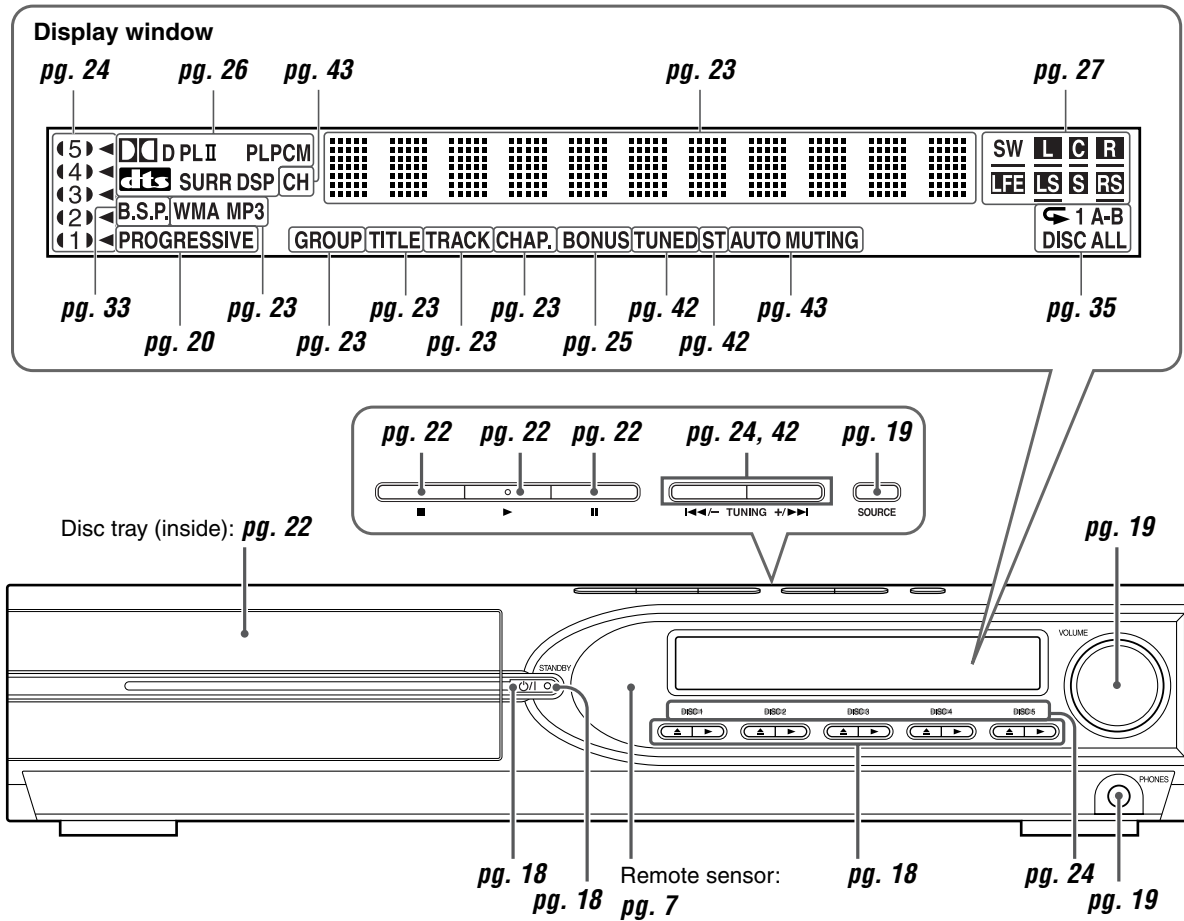

Rear panel (center unit)

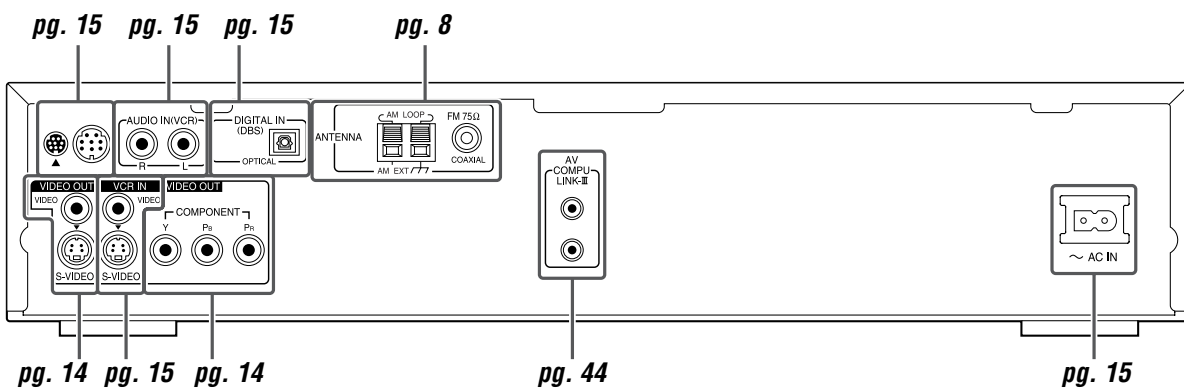

Powered subwoofer

SP-PWM606/SP-PWM505/SP-PWM501

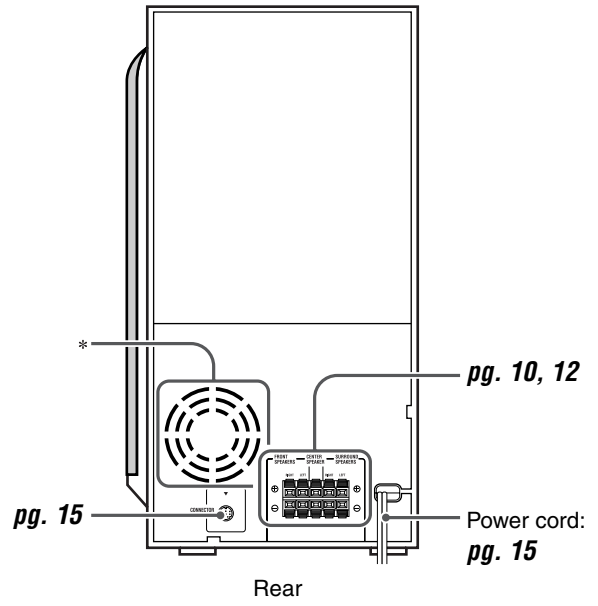
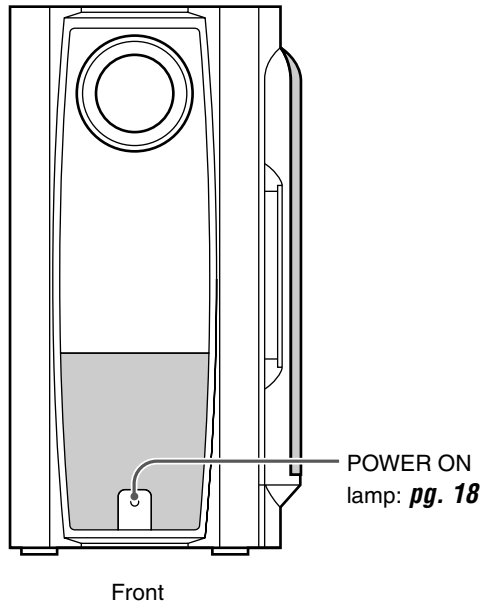

SP-PWM603/SP-PWM303/SP-PWM301

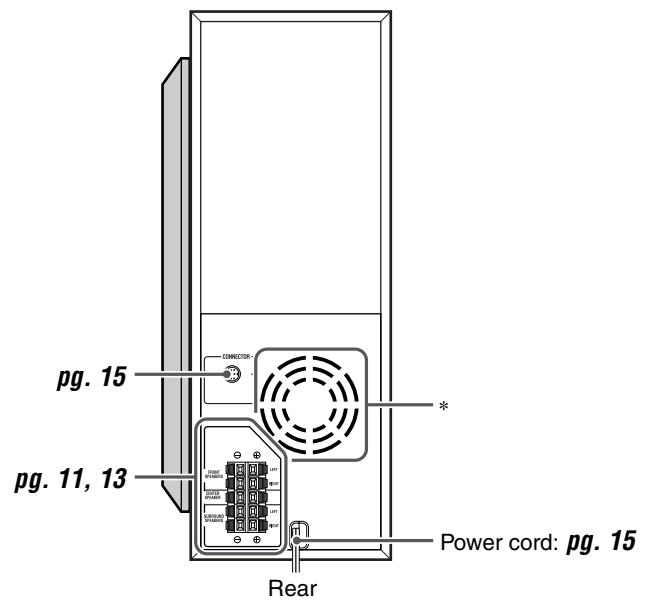
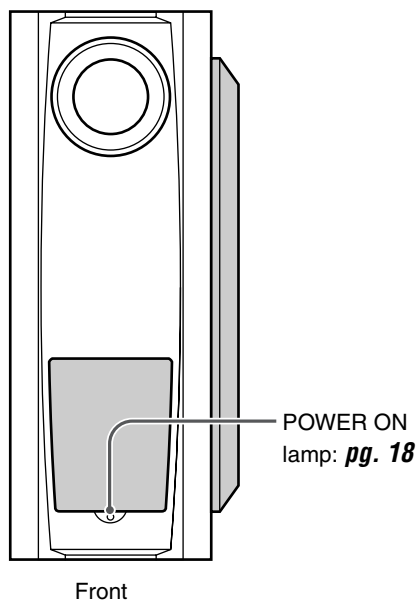

* Do not block the ventilation openings.

NOTE

- For safety reasons, always ensure that there is sufficient space behind the powered subwoofer.

Remote control

Putting batteries in the remote control

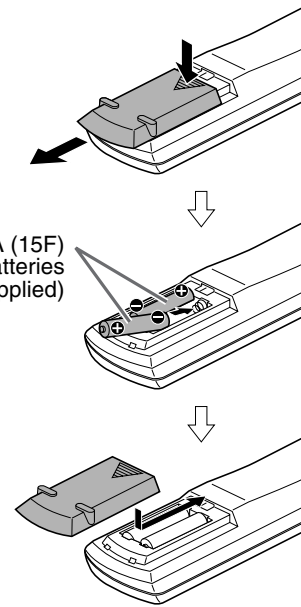
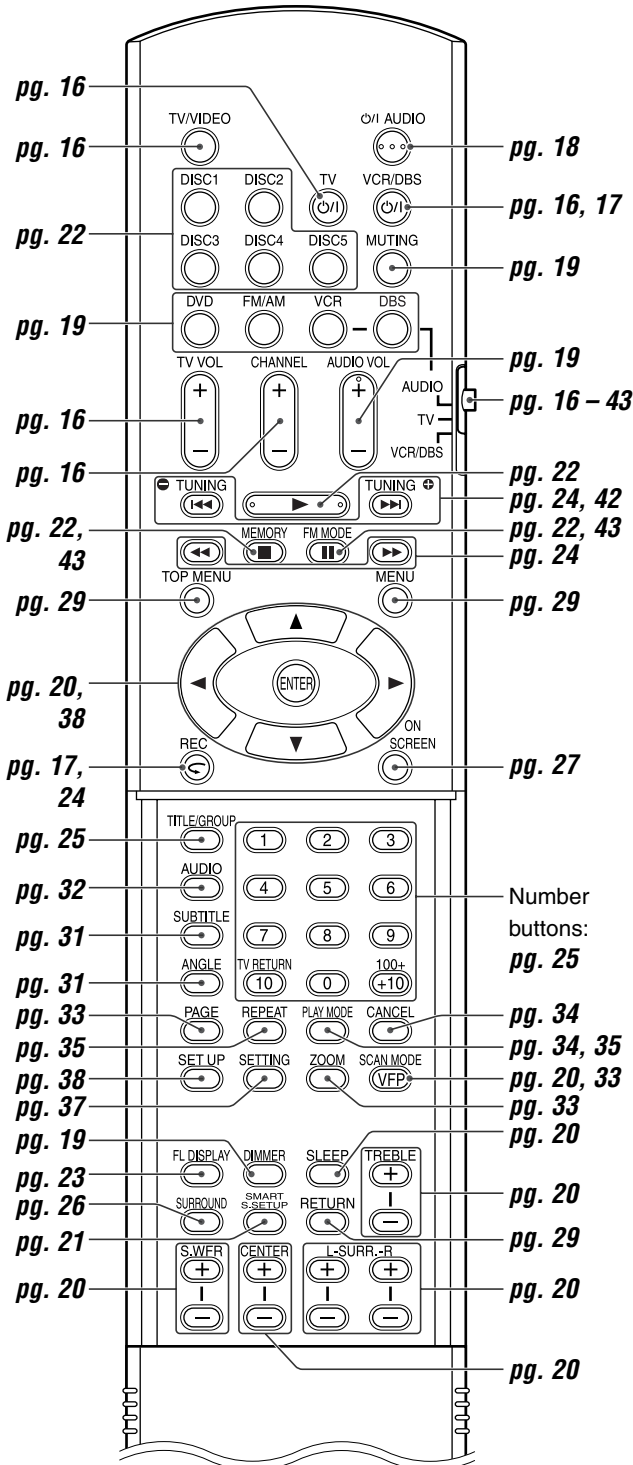

R6P (SUM-3)/AA (15F)
type dry-cell batteries
(supplied)

If the range or effectiveness of the remote control decreases, replace both batteries.

CAUTION

- Do not expose batteries to heat or flame.

Operating the system from the remote control

Aim the remote control directly to the front panel of the center unit.

- Do not hide the remote sensor.

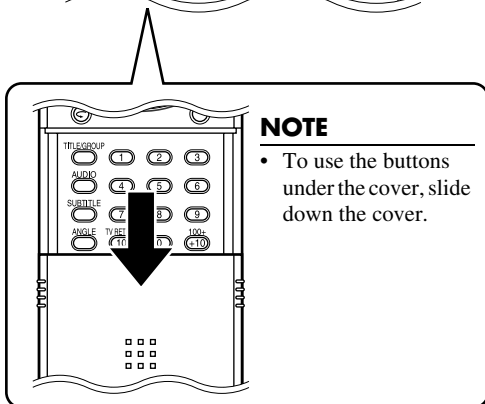

NOTE

- To use the buttons under the cover, slide down the cover.

Connecting the FM and AM antennas

■ AM loop antenna

Setting up supplied AM loop antenna

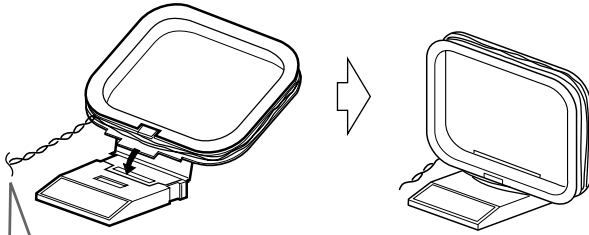

If the antenna cord is covered with the insulation coat, twist and pull the insulation coat off and remove.

Connecting AM loop antenna

1

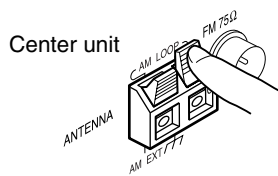

2

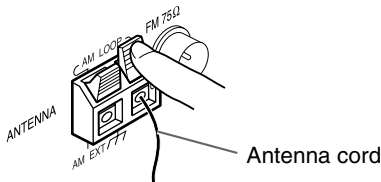

3

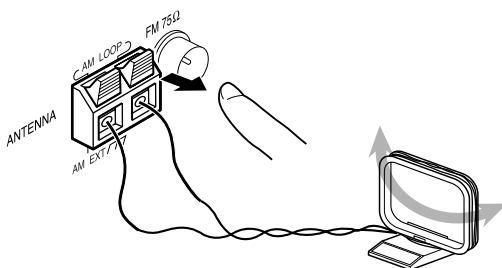

- Turn the loop antenna until you have the best reception during AM broadcast program reception.

NOTE

- Make sure the antenna conductors do not touch any other terminals, connecting cords and power cords. This could cause poor reception.

If reception is poor

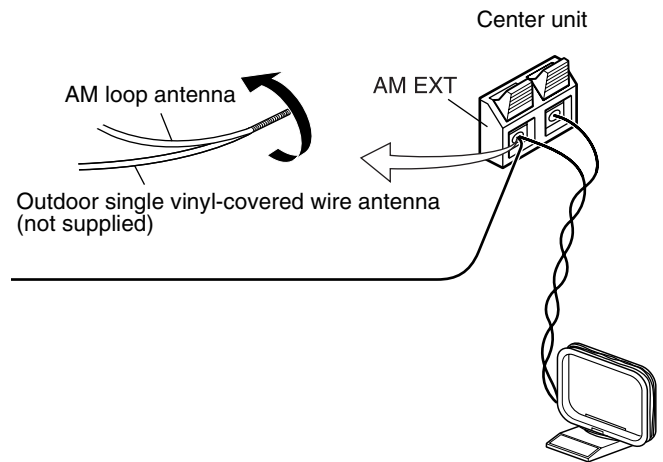

■ FM antenna

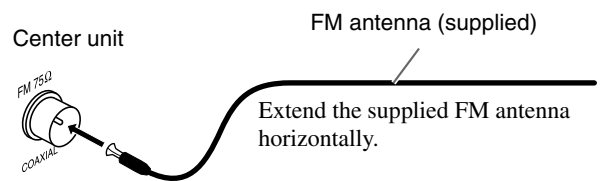

If reception is poor

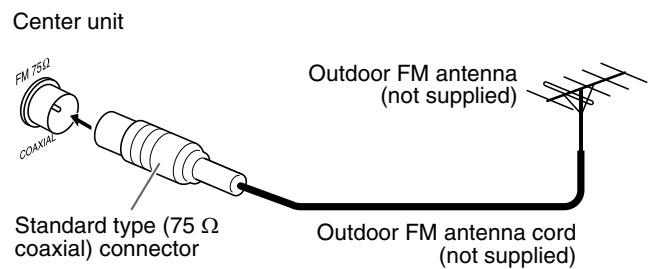

NOTE

- We recommend that you use coaxial cable for the FM antenna as it is well-shielded against interference.

Assembling the front and surround speakers

The following procedure explains the front speaker assembly. The assembly of both the front and surround speakers are done in the same manner.

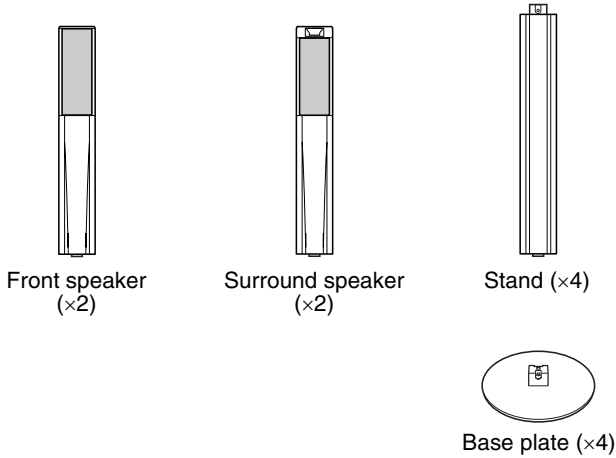

NOTE

- The stands and the base plates are commonly used for both front and surround speakers assembly.

Before assembling —

- Prepare a Phillips screwdriver (not supplied).
- Take care not to drop the base plate while assembling; otherwise, it may cause damage to the floor or injury.

1

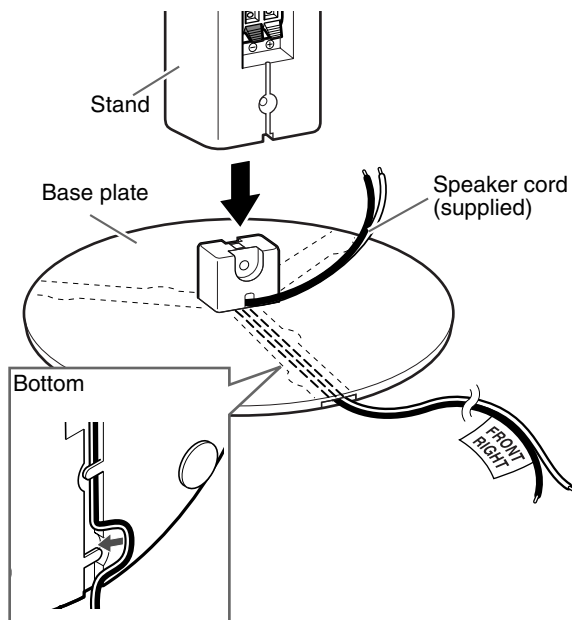

- You can route the speaker cords through one on the three grooves on the base plate depending on the speaker layout.
- Depending on the installing condition, you can assemble the front and surround speakers without the stands. In such a case, attach the speaker directly to the base plate instead of the stand.

2

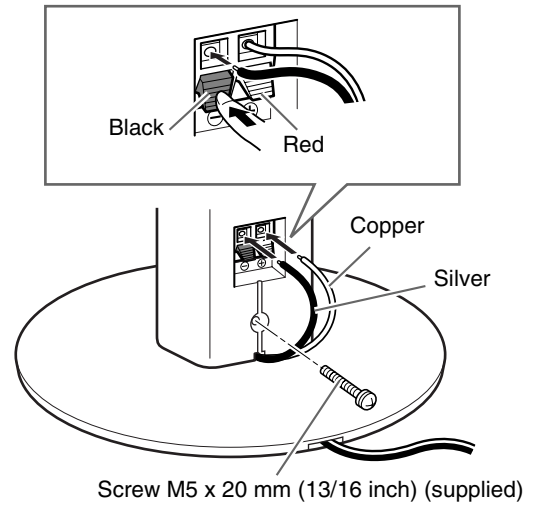

3

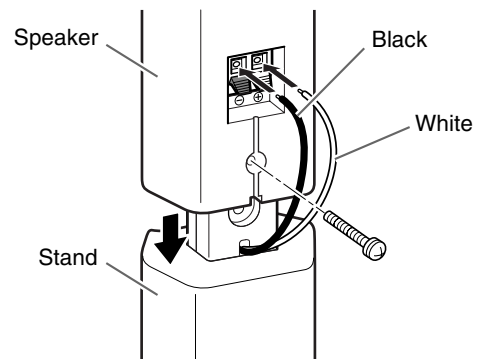

Completion

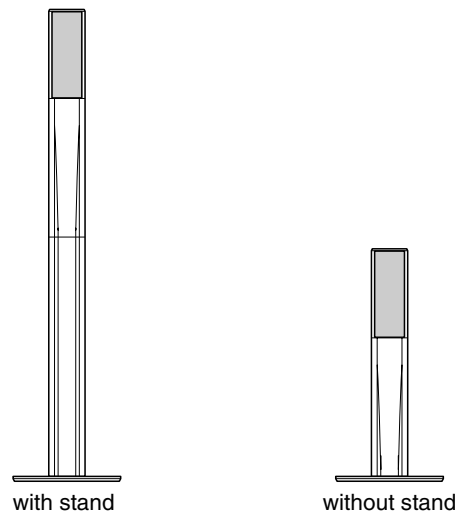

Connecting the satellite (front, center, surround) speakers

Before connecting the speaker cords;
Twist and pull the insulation coat off and remove.

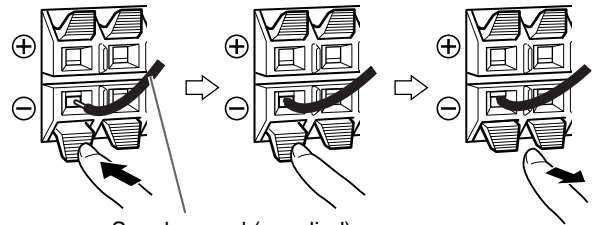

Speaker cord (supplied)

- Connect the silver cords to the black (⊖) terminals.
- Connect the copper cords to the (⊕) terminals referring to the table below:

| | |
|---------------------------|-------|
| FRONT SPEAKERS (RIGHT) | Red |
| FRONT SPEAKERS (LEFT) | White |
| CENTER SPEAKER | Green |
| SURROUND SPEAKERS (RIGHT) | Gray |
| SURROUND SPEAKERS (LEFT) | Blue |

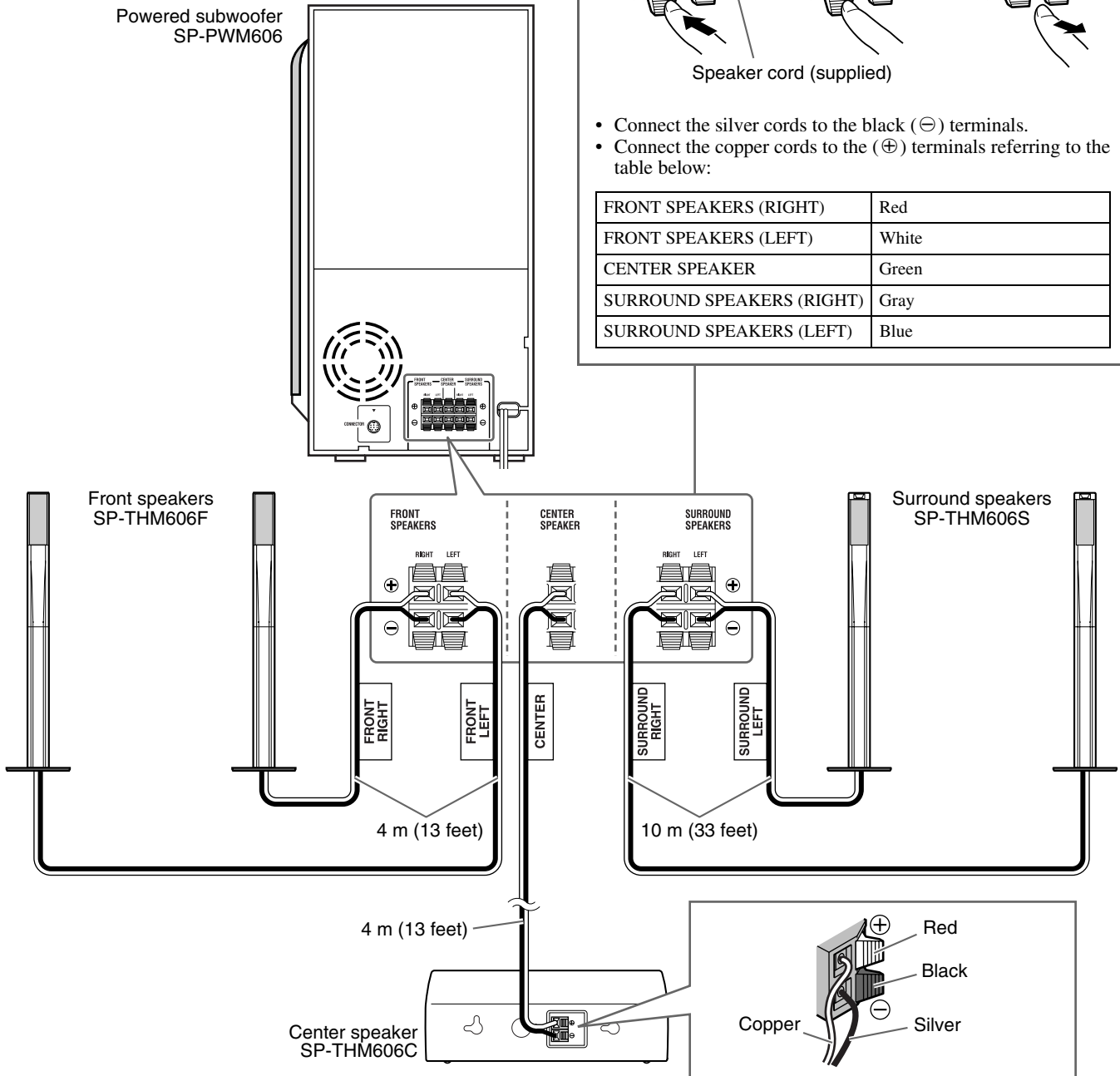

CAUTION

- When you connect speakers other than the supplied ones, use speakers with the same speaker impedance (SPEAKER IMPEDANCE) indicated near the speaker terminals on the rear of the powered subwoofer.
- DO NOT connect more than one speaker to one speaker terminal.

Continued on next page

Before connecting the speaker cords;

Twist and pull the insulation coat off and remove.

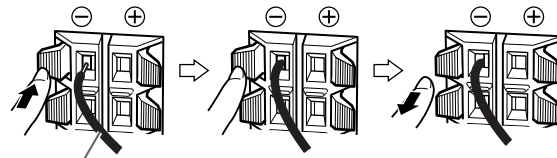

Speaker cord (supplied)

- Connect the silver cords to the black (⊖) terminals.
- Connect the copper cords to the (⊕) terminals referring to the table below:

| | |
|---------------------------|-------|
| FRONT SPEAKERS (LEFT) | White |
| FRONT SPEAKERS (RIGHT) | Red |
| CENTER SPEAKER | Green |
| SURROUND SPEAKERS (LEFT) | Blue |
| SURROUND SPEAKERS (RIGHT) | Gray |

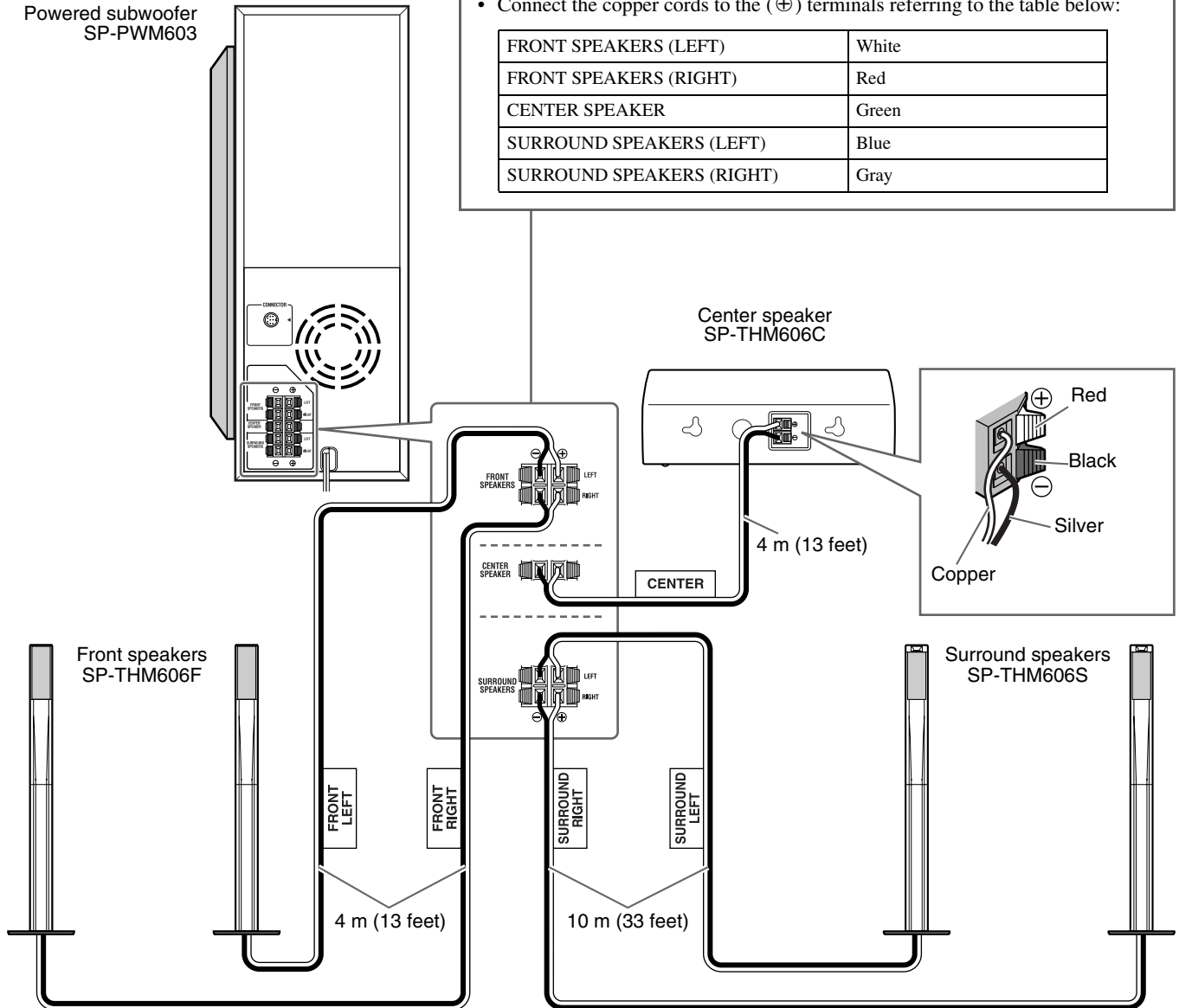

CAUTION

- When you connect speakers other than the supplied ones, use speakers with the same speaker impedance (SPEAKER IMPEDANCE) indicated near the speaker terminals on the rear of the powered subwoofer.
- DO NOT connect more than one speaker to one speaker terminal.

Note that the illustration below is for TH-M505.

Before connecting the speaker cords;
Twist and pull the insulation coat off and remove.



Speaker cord (supplied)

- Connect the silver cords to the black (⊖) terminals.
- Connect the copper cords to the (⊕) terminals referring to the table below:

| | |
|---------------------------|-------|
| FRONT SPEAKERS (RIGHT) | Red |
| FRONT SPEAKERS (LEFT) | White |
| CENTER SPEAKER | Green |
| SURROUND SPEAKERS (RIGHT) | Gray |
| SURROUND SPEAKERS (LEFT) | Blue |

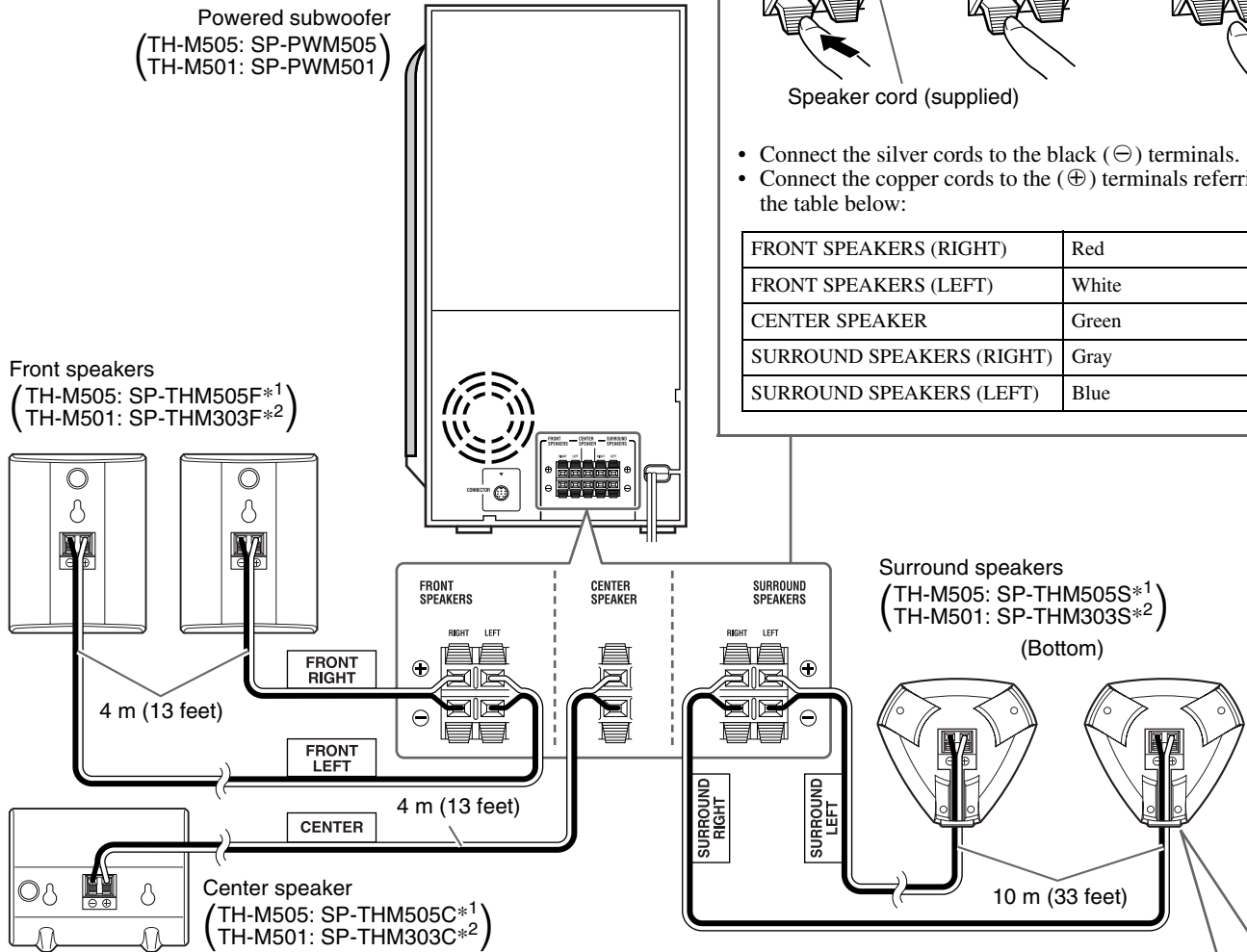

*1 For TH-M505

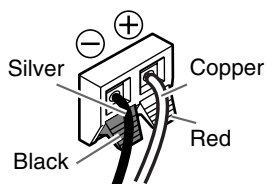

*2 For TH-M501, the satellite speakers are equipped with their speaker cords attached directly to their speaker unit instead of having speaker terminals on their cabinet.

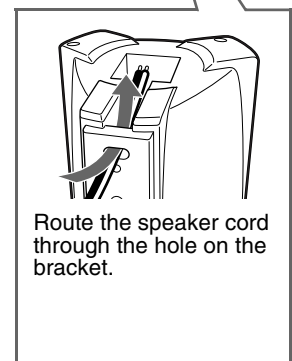
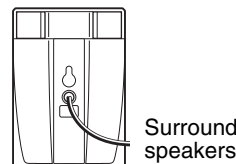
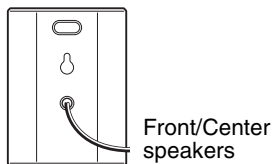

CAUTION

- When you connect speakers other than the supplied ones, use speakers of the same speaker impedance (SPEAKER IMPEDANCE) indicated near the speaker terminals on the rear of the powered subwoofer.
- DO NOT connect more than one speaker to one speaker terminal.

- When installing the satellite speakers on the wall;
 - Be sure to have them installed on the wall by a qualified personnel. DO NOT install the satellite speakers on the wall by yourself to avoid unexpected damage from their falling off the wall due to incorrect installation or weakness in wall structure.
 - Care must be taken in selecting a location for speaker installation on a wall. Injury to personnel or damage to equipment may result if the speakers installed interfere with daily activities.

Continued on next page

Before connecting the speaker cords;
Twist and pull the insulation coat off and remove.

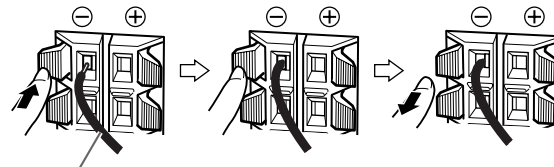

Speaker cord (supplied)

- Connect the silver cords to the black (⊖) terminals.
- Connect the copper cords to the (⊕) terminals referring to the table below:

| | |
|---------------------------|-------|
| FRONT SPEAKERS (LEFT) | White |
| FRONT SPEAKERS (RIGHT) | Red |
| CENTER SPEAKER | Green |
| SURROUND SPEAKERS (LEFT) | Blue |
| SURROUND SPEAKERS (RIGHT) | Gray |

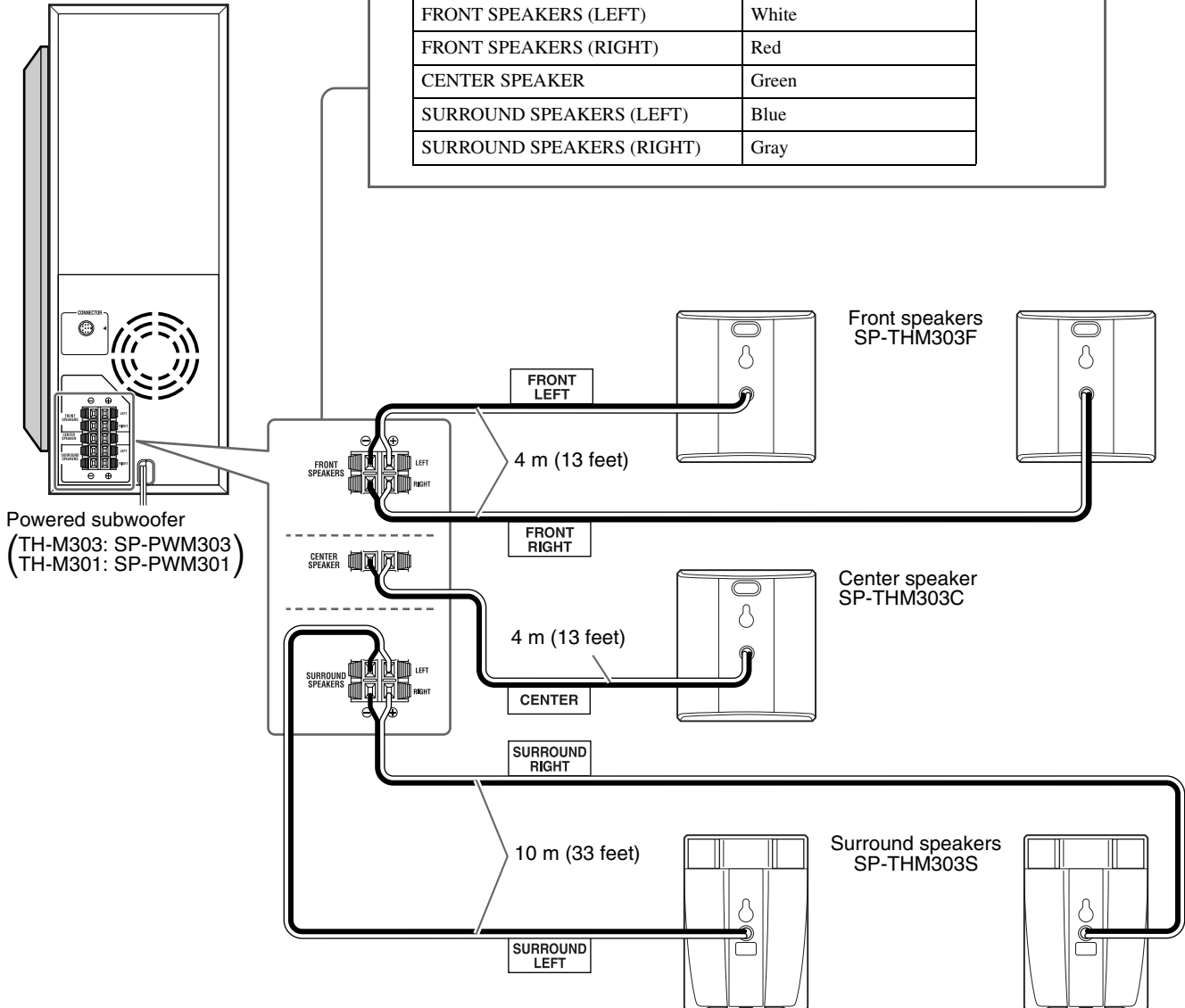

CAUTION

- When you connect speakers other than the supplied ones, use speakers of the same speaker impedance (SPEAKER IMPEDANCE) indicated near the speaker terminals on the rear of the powered subwoofer.
- DO NOT connect more than one speaker to one speaker terminal.

- When installing the satellite speakers on the wall;
 - Be sure to have them installed on the wall by a qualified personnel. DO NOT install the satellite speakers on the wall by yourself to avoid unexpected damage from their falling off the wall due to incorrect installation or weakness in wall structure.
 - Care must be taken in selecting a location for speaker installation on a wall. Injury to personnel or damage to equipment may result if the speakers installed interfere with daily activities.

Speaker layout

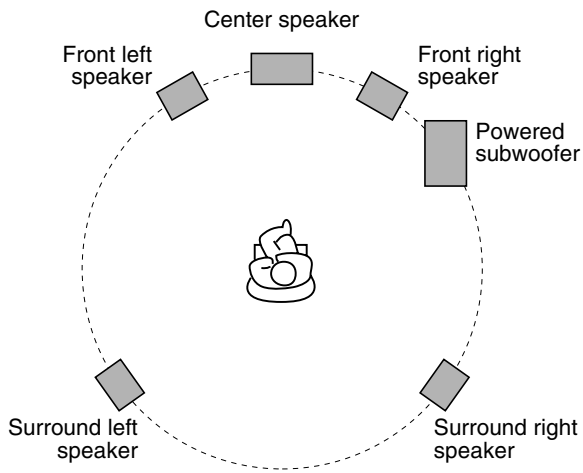

NOTE

- Although the satellite speakers and the powered subwoofer are magnetically shielded, the TV screen may appear mottled. In this case, keep enough distance between the speakers and the TV.
- The speakers are magnetically shielded to avoid color distortions on TVs. However, if not installed properly, they may cause color distortions. So, pay attention to the following when installing the speakers.
 - When placing the speakers near a TV set, turn off the TV's main power switch or unplug it before installing the speakers. Then wait at least 30 minutes before turning on the TV's main power switch again.

Some TVs may still be affected even though you have followed the above. If this happens, move the speakers away from the TV.

- Place the satellite speakers on a flat and level surface.
- Be sure to place the powered subwoofer to the TV's right. If you place the powered subwoofer to the TV's left, keep sufficient distance between them to prevent the TV screen from appearing mottled.

For TH-M606/TH-M603 only:

- Do not lean against the satellite speakers, as the speakers could fall down or break, possibly causing injury. Especially be careful not to let children lean against them.

Connecting a TV

- You can get better picture quality in the order — Component video > S-video > Composite video.
- Distortion of picture may occur when connecting to the TV via a VCR, or to a TV with a built-in VCR.
- You need to set "MONITOR TYPE" in the PICTURE menu correctly according to the aspect ratio of your TV. (☞ pg. 39)

■ To connect a TV equipped with the component video input jacks

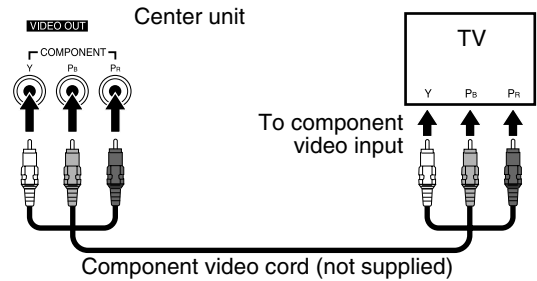

NOTE

- If your TV supports progressive video input, you can enjoy a high quality picture by setting the progressive scan mode to active. (☞ pg. 20)
- If the component video input jacks of your TV are of the BNC type, use a plug adapter (not supplied) to convert the pin plugs to BNC plugs.
- The component video signals can be output only when you select "DVD" as the source to play. (☞ pg. 19)

■ To connect a TV equipped with the composite or S-video jacks

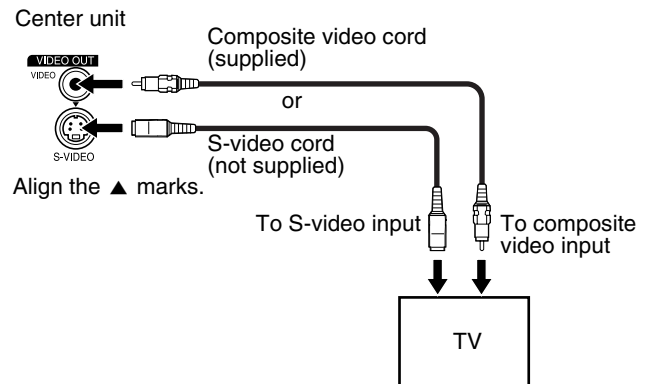

Connecting the powered subwoofer

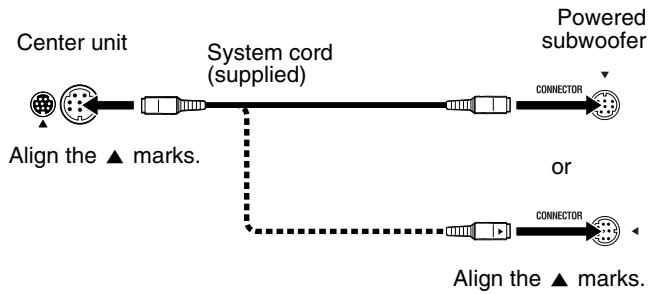

NOTE

- The way of connecting the system cord varies depending on the type of the powered subwoofer.

Connecting to an analog component

You can enjoy the sound of an analog component.

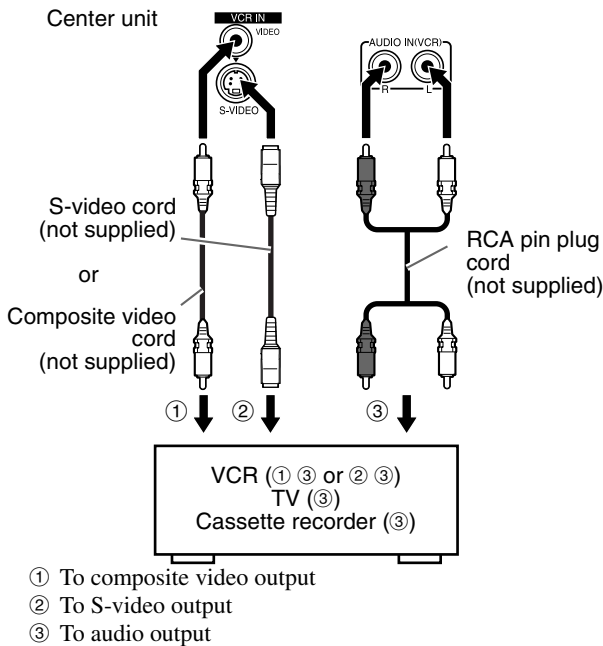

NOTE

- The signals input to the VIDEO jack of the VCR IN jacks will be output only from the VIDEO jack of the VIDEO OUT jacks, not from the S-VIDEO jack of the VIDEO OUT jacks.

Connecting to a digital component

You can enjoy the sound of a digital component.

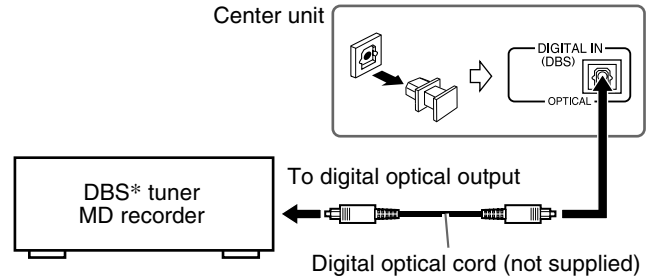

* DBS = Direct Broadcasting Satellite

NOTE

- Only digital audio signals can be input when selecting “DBS” as the source to play. (pg. 19) When connecting a video component such as a DBS tuner, operate this system to listen to the sound.

Connecting the power cord

Make sure that all other connections have been completed.

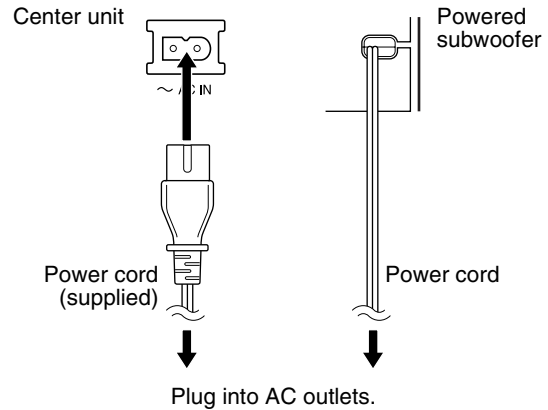

CAUTION

- Disconnect the power cord before cleaning or moving the system.
- Do not pull on the power cord to unplug the cord. When unplugging the cord, always grasp and pull the plug so as not to damage the cord.

Operating external components with the remote control

The buttons described below are used on pages 16 and 17.

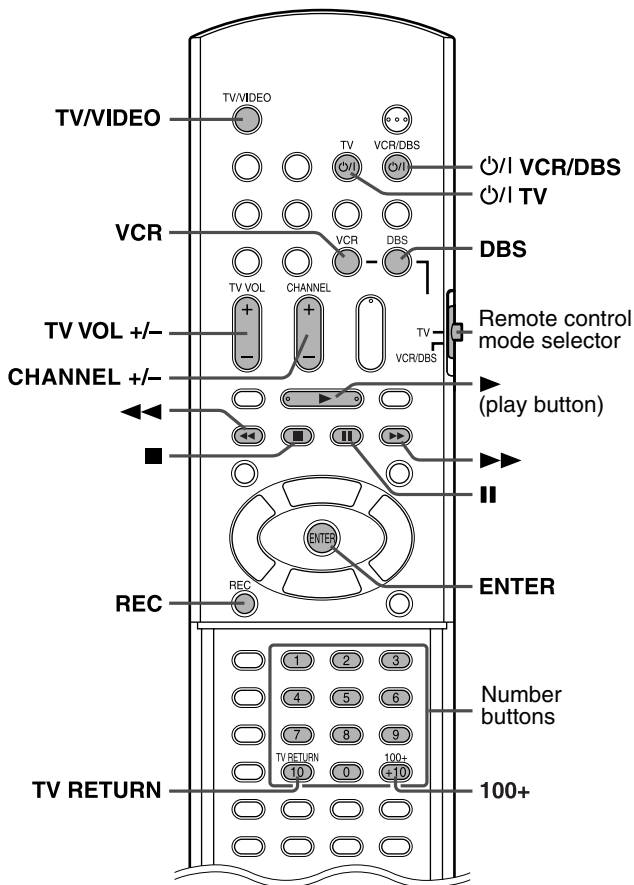

NOTE

- Manufacturers' codes are subject to change without notice.
- Set the codes again after replacing the batteries of the remote control.

Operating the TV

■ To set the manufacturer's code

You can operate a JVC TV without setting the manufacturer's code.

- 1 Slide the remote control mode selector to TV.**
- 2 Press and hold \odot/TV .**
Keep the button pressed until step 4 is finished.
- 3 Press ENTER.**

4 Press number buttons (1-9, 0) to enter the manufacturer's code (2 digits).

Examples:

For a Hitachi TV:

Press 1, then 0.

For a Toshiba TV:

Press 0, then 8.

| Manufacturer | Code | Manufacturer | Code |
|--------------|--------|--------------|------|
| JVC | 01 | Samsung | 12 |
| Hitachi | 10 | Sharp | 06 |
| Magnavox | 02 | Sony | 07 |
| Mitsubishi | 03 | Toshiba | 08 |
| Panasonic | 04, 11 | Zenith | 09 |
| RCA | 05 | | |

5 Release \odot/TV .

If there is more than one code listed for corresponding brand, try each one until you enter the correct one.

■ Operation

Aim the remote control at the TV.

IMPORTANT

Before using the remote control to operate a TV;

- Set the remote control mode selector to TV.

The following buttons are available:

- \odot/TV : Turns TV on and off.
- TV VOL +/-: Adjusts the volume.
- TV/VIDEO: Selects the input mode (either TV or VIDEO).
- CHANNEL +/-: Changes the channels.
- 1-10, 0, +10 (100+): Selects the channel.
- TV RETURN: Alternates between the previously selected channel and the current channel.

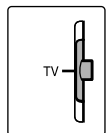

Operating the DBS tuner or CATV converter

■ To set the manufacturer's code

- 1 Slide the remote control mode selector to VCR/DBS.**
- 2 Press DBS.**
- 3 Press and hold $\odot/\text{VCR/DBS}$.**
Keep the button pressed until step 5 is finished.
- 4 Press ENTER.**

Continued on next page

5 Press number buttons (1-9, 0) to enter the manufacturer's code (2 digits).

Examples:
 For a GI Jerrold product:
 Press 0, then 1.
 For a Sony product:
 Press 2, then 0.

| Manufacturer | Code |
|--------------------|--------------------------------|
| Echostar | 21 |
| GI Jerrold | 01, 02, 03, 04, 05, 06, 07, 08 |
| Hamlin | 15, 16, 17, 18 |
| Pioneer | 13, 14 |
| RCA | 19 |
| Scientific Atlanta | 09, 10 |
| Sony | 20 |
| Zenith | 11, 12 |

6 Release VCR/DBS.

If there is more than one code listed for your brand, try each one until you enter the correct one.

■ Operation

Aim the remote control at the DBS tuner or CATV converter.

IMPORTANT

Before using the remote control to operate a DBS tuner or CATV converter;

- 1 Set the remote control mode selector to VCR/DBS.
- 2 Press DBS.

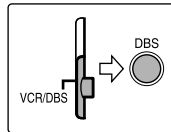

The following buttons are available:

-  VCR/DBS: Turns DBS tuner or CATV converter on and off.
- CHANNEL +/-: Changes the channels.
- 1-10, 0, +10 (100+): Selects the channel.

Operating the VCR

■ To set the manufacturer's code

1 Slide the remote control mode selector to VCR/DBS.

2 Press VCR.

3 Press and hold VCR/DBS.

Keep the button pressed until step 5 is finished.

4 Press ENTER.

5 Press number buttons (1-9, 0) to enter the manufacturer's code (2 digits).

Examples:
 For a Philips VCR:
 Press 0, then 9.
 For an NEC VCR:
 Press 2, then 5.

| Manufacturer | Code | Manufacturer | Code |
|--------------|----------------|--------------|------------|
| JVC | 01, 02, 03 | Philips | 09 |
| Emerson | 11, 26 | RCA | 05, 06 |
| Fisher | 29 | Samsung | 24 |
| Funai | 10, 14, 15, 16 | Sanyo | 21, 22, 23 |
| Gold Star | 12 | Sharp | 27, 28 |
| Hitachi | 04 | Shintom | 30 |
| Mitsubishi | 13 | Sony | 18, 19, 20 |
| NEC | 25 | Zenith | 08 |
| Panasonic | 07, 17 | | |

6 Release VCR/DBS.

If there is more than one code listed for your brand, try each one until you enter the correct one.

■ Operation

Aim the remote control at the VCR.







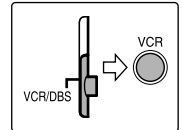

IMPORTANT

Before using the remote control to operate a VCR;

- 1 Set the remote control mode selector to VCR/DBS.
- 2 Press VCR.



The following buttons are available:

-  VCR/DBS: Turns VCR on and off.
-  (play button): Starts playback.
-  : Stops operation.
-  : Pauses playback.
-  : Fast forwards video tape.
-  : Rewinds video tape.
- REC: Press this button together with  (play button) to start recording or together with  to pause recording.

CHANNEL +/-: Changes the TV channels on the VCR.

NOTE

When operating a VCR or DBS tuner/CATV converter;

- The source setting of VCR or DBS remains after you have changed the remote control mode selector to AUDIO or TV. When operating VCR or DBS tuner/CATV converter again, it is not necessary to press VCR or DBS after setting the remote control mode selector.

Basic operations

The buttons on the remote control are used to explain most of the operations in this manual. You can use the buttons on the center unit same as on the remote control for operations unless otherwise noted.

IMPORTANT

Before using the remote control for the following operation;

- Set the remote control mode selector to AUDIO.

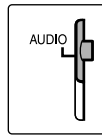

The buttons described below are used on pages 18 to 21.

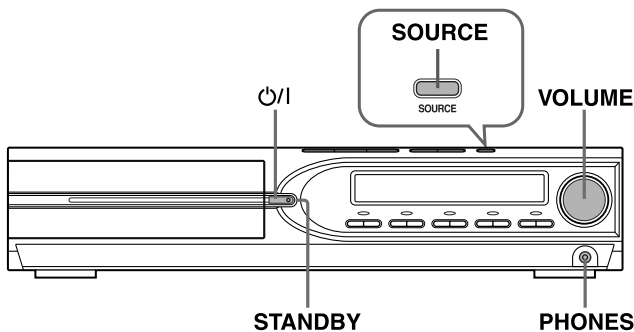
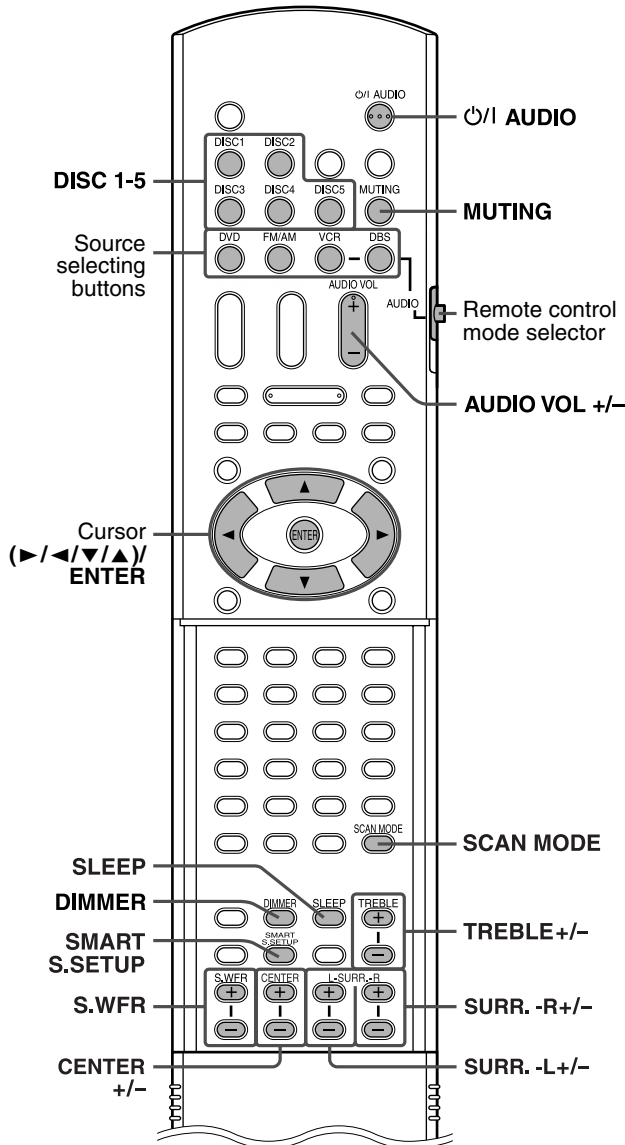

Turning the system on/off

On the remote control:

Press **⏻ AUDIO**.

On the center unit:

Press **⏻**.

When DVD is selected as the source (pg. 19), the following messages will appear on the TV screen.

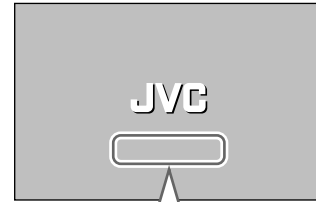

- “OPEN”/“CLOSE”:
Appears when opening or closing the disc tray.
- “NOW READING”:
Appears when the system is reading the disc information.
- “REGION CODE ERROR!”:
Appears when the Region Code of the DVD VIDEO does not match the code the system supports. The disc cannot be played back.
- “NO DISC”:
Appears when no disc is loaded.
- “CANNOT PLAY THIS DISC”:
Appears when unplayable disc is loaded.

NOTE

- The STANDBY lamp turns on when the power is turned off and turns off when the power is turned on.
- The power supply to the subwoofer is linked to the center unit. The POWER ON lamp on the subwoofer lights green when the power is turned on.
- A small amount of the power is consumed even when the power is turned off (center unit only). This is called standby mode and the STANDBY lamp lights in this mode. Unplug the power cord from the AC outlet to turn the power off completely.
- You can also turn on the system by pressing the following buttons;
 - One of **▲** buttons on the center unit
 - One of the source selecting buttons on the remote control
 - One of the DISC (1-5) **▶** buttons or **▶** on the center unit.
 You can use the same buttons on the remote control except after pressing FM/AM.

Selecting the source to play

On the remote control:

Press one of the source selecting buttons (DVD, FM/AM, VCR or DBS).

DVD: To play back a disc (DVD VIDEO, VCD etc.). (☞ pg. 22)

FM/AM: To tune in an FM or AM station. (☞ pg. 42)

Each time you press the button, the band alternates between FM and AM.

VCR: To select the source from a component connected to the VCR IN jacks and AUDIO IN (VCR) jacks. (☞ pg. 15)

DBS: To select the source from a component connected to the DIGITAL IN (DBS) jack. (☞ pg. 15)

On the center unit:

Press SOURCE repeatedly until the source name you want appears on the display window.

NOTE

- When AM, FM or DBS is selected as the source, the system does not output video signals.
- It may take time to change the source.

Adjusting the volume [VOLUME]

CAUTION

- Always set the volume to minimum level before starting any source. If the volume is set at its high level, the sudden blast of sound could permanently damage your hearing and/or blow out the speakers.

On the remote control:

Press AUDIO VOL + or –.

On the center unit:

Turn VOLUME.

Listening with headphones (not supplied)

CAUTION

Be sure to turn down the volume;

- Before connecting or putting on headphones as high volume may damage both the headphones and your hearing.
- Before disconnecting headphones as high volume may be suddenly output from the speakers.

While connecting a pair of headphones to the PHONES jack on the center unit, the system automatically cancels the surround mode (☞ pg. 26) currently selected, deactivates the speakers, turn the subwoofer's power off, and activates the headphone mode. "HEADPHONE" appears on the display window.

Headphone mode

When using the headphones, the following signals are output regardless of your speaker setting;

- For 2 channel sources, the front left and right channel signals are output from the headphones.
- Multi-channel signals are down-mixed and output from the headphones.
- (DVD AUDIO) When the disc prohibits down-mixing, only the front left and right channels are output from the headphones. In this case, "L/R ONLY" appears on the display window for a few seconds.

Turning off the sound temporarily [MUTING]

Press MUTING.

To restore the sound

Perform one of the following:

- Press MUTING again.
- Press AUDIO VOL +/- (or turn VOLUME on the center unit).

Adjusting the brightness of the indications [DIMMER]

Press DIMMER.

Each time you press the button, the brightness level changes.

Sleep Timer [SLEEP]

The system turns off automatically when the specified period of time has passed.

Press SLEEP.

Each time you press the button, the shut-off time changes.

Example:



To check the remaining time

Press SLEEP once.

To change the remaining time

Press SLEEP repeatedly.

To cancel

Press SLEEP repeatedly until "SLEEP OFF" appears.

- Turning off the power also cancels the Sleep Timer.

Adjusting the output level of the subwoofer and center/surround speakers [SUBWFR, CENTER, SURR L/R]

Press S.WFR +/- to adjust the subwoofer.

Press CENTER +/- to adjust the center speaker.

Press SURR.-L +/- to adjust the surround left speaker.

Press SURR.-R +/- to adjust the surround right speaker.

NOTE

- You can also make adjustments by using the setup menu shown on the TV screen. (☞ pg. 39)
- The adjustments take effect for all sources.
- You cannot make this adjustment when FM or AM is selected as the source.

Adjusting the treble sound [TREBLE]

Press TREBLE +/-.

NOTE

- The adjustments take effect for all sources.

Changing the scan mode

The system can be accommodated to your TV's scan mode.

NOTE

- To use the system in PROGRESSIVE mode, it is required that the center unit is connected to the TV by using a component video cord (not supplied). (☞ pg. 14)

- While DVD is selected as the source and stopped

1 Press and hold SCAN MODE for 2 seconds.

"INTERLACE" or "PROGRESSIVE" appears on the display window.

2 Press Cursor ▶/◀ to select the desired mode.

- INTERLACE: Select this when your TV supports the interlaced video input only.
- PROGRESSIVE: Select this when your TV equipped with component jacks supports the progressive video input.

You can get better picture quality in PROGRESSIVE mode than in INTERLACE mode.

3 Press ENTER while the selected mode is displayed.

When "PROGRESSIVE" is selected, the PROGRESSIVE indicator lights on the display window.

NOTE

- Although the picture may be distorted when you press ENTER, this is not a malfunction of the system.
- "INTERLACE" is selected at your purchase.

- There are some progressive TVs and High-Definition TVs that are not fully compatible with this system, resulting in an unnatural picture when playing back a DVD VIDEO in the progressive scan mode. In such a case, change the scan mode to "INTERLACE". To check the compatibility of your TV, contact your local JVC customer service center.
- All JVC progressive TVs and High-Definition TVs are fully compatible with this system.

Optimizing the speaker settings [Smart Surround Setup]

NOTE

- When you change the positioning of the speakers or listener, or replace the supplied speakers with other ones, perform Smart Surround Setup again.
- While DVD is selected as the source and stopped

1 Take your position where you listen to the sound.

2 Press and hold SMART S.SETUP.

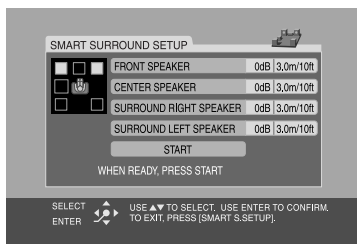

“SETTING UP” flashes on the display window.

3 Press ENTER, press Cursor ▼/▲ to select the distance between the front speakers and the listening position, then press ENTER.



4 Press Cursor ▼/▲ to select START, then press ENTER.

5 Clap your hands over your head once.

6 Make sure that “COMPLETED !” appears on the TV screen, then press SMART S.SETUP.

The system detects your clapping sound through the satellite speakers, then automatically makes the best settings for each speaker. “COMPLETED !” appears on the TV screen when Smart Surround Setup completes.

When “FAILED !” appears on the TV screen

The system could not detect the clapping sound correctly. In such a case, follow the instructions that appears on the TV screen.

- When the system detects the clapping sound as “FAILED !” three times, set the distance (DISTANCE) and the output level (LEVEL) manually (☞ pg. 39).

To cancel

Press SMART S.SETUP.

NOTE

- You need to set the subwoofer’s output level (LEVEL) manually. (☞ pg. 20 or 39)
- In step 2, “SW ERROR” appears on the display window if the center unit and the powered subwoofer are not connected correctly by using the supplied system cord.

Playback

- The icon such as  shows the types of discs the operation is available for.

IMPORTANT

Before using the remote control for the following operation;

- Set the remote control mode selector to AUDIO.
- Press DVD.

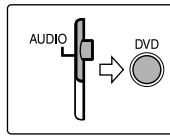

The buttons described below are used on pages 22 to 25.

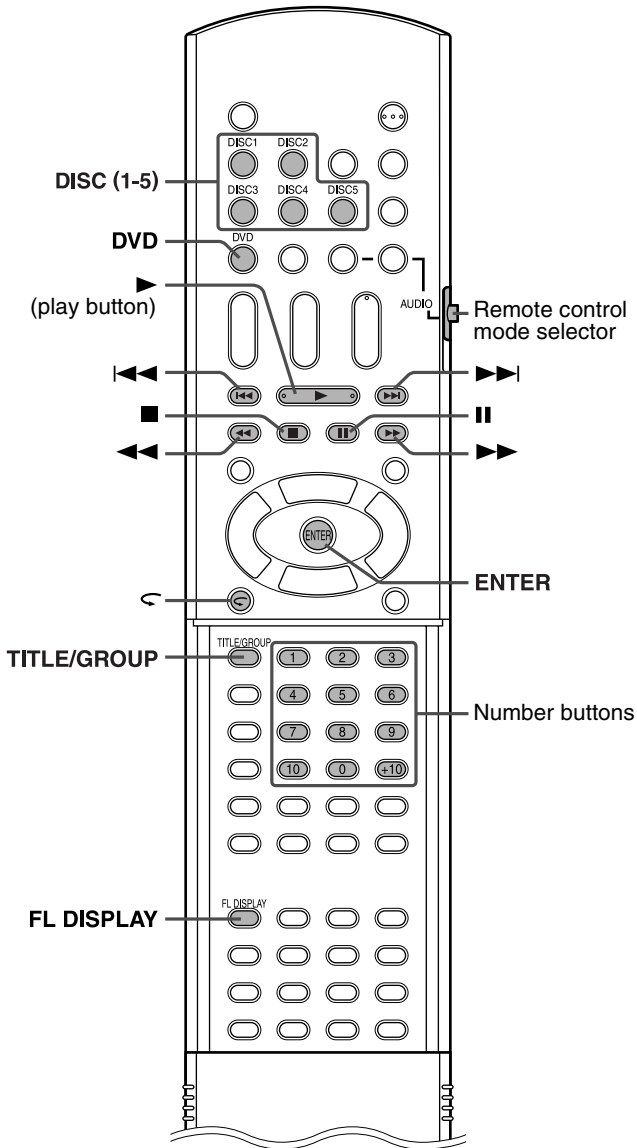

Disc lamps
(TH-M606/TH-M603/TH-M505/
TH-M501 only)

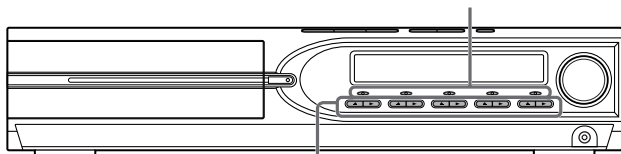

DISC (1-5) ▲/▶

Basic playback

- Press the desired **DISC (1-5) ▲** on the center unit.

| | | | |
|-----------|-----------|------|--------|
| DVD VIDEO | DVD AUDIO | VCD | SVCD |
| CD | MP3 WMA | JPEG | MPEG 4 |

- The system turns on and the disc tray comes out.

- Place a disc.

Label side up

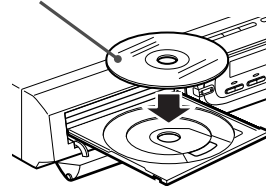

When placing an 8 cm (3 inches) disc

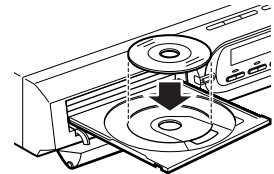

- Press DISC (1-5).

For MP3/WMA disc

The file control display (☞ pg. 30) appears on the TV screen.

For JPEG disc

Each file (still pictures) is shown on the TV screen for about 3 seconds (slide-show). When stopping playback, the file control display (☞ pg. 30) appears on the TV screen.

For MPEG4 disc

Pressing TOP MENU or MENU shows the file control display (☞ pg. 30) on the TV screen during playback.

■ To pause playback

Press **II**.











To return to playback, press **▶** (play button).

■ To stop

Press **■**.

■ On-screen guide icons

During DVD VIDEO playback, the following guide icons may appear for a while on the TV screen;

- : appears at the beginning of a scene containing multi-subtitle languages.
- : appears at the beginning of a scene containing multi-audio languages.
- : appears at the beginning of a scene containing multi-angle views.
-  (Play),  (Pause),  /  (Fast forward/fast-reverse),  /  (Slow-motion forward/reverse): appears when you perform each operation.
- : the disc cannot accept an operation you have tried to do.

Continued on next page

NOTE

- Up to 5 discs can be loaded.
- You can also start playback by pressing ► (play button) or DVD.
- The system plays back available discs sequentially until you stop playback or until the disc loaded on the DISC 5 tray reaches to the end.
- (For JPEG) The system cannot accept operations even though you press any buttons before the entire picture appears on the TV screen.
- If you do not want the on-screen guide icons to appear, see page 40.

■ Playback information on the display window

DVD VIDEO

Example:

When a DVD VIDEO encoded with Dolby Digital 5.1ch is played

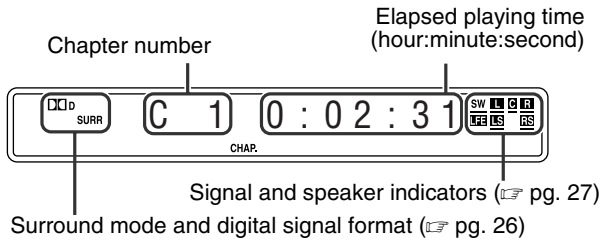

Pressing FL DISPLAY

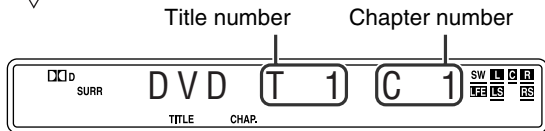

DVD AUDIO

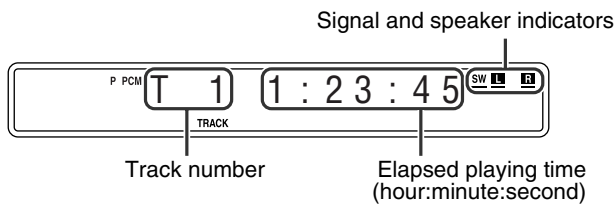

Pressing FL DISPLAY

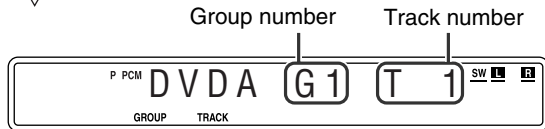

VCD/SVCD/CD

Example:

When a CD is played back

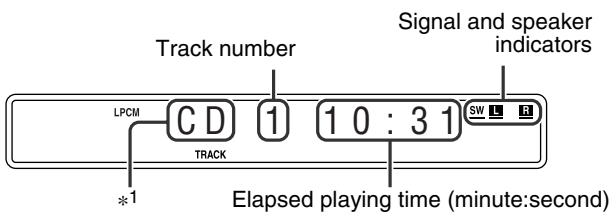

*1 VCD indication appears for VCD/SVCD.

NOTE

- When a VCD or SVCD with PBC function is played, the elapsed playing time does not appear, but "PBC" appears.

MP3/WMA disc

Example:

When an MP3 disc is played back

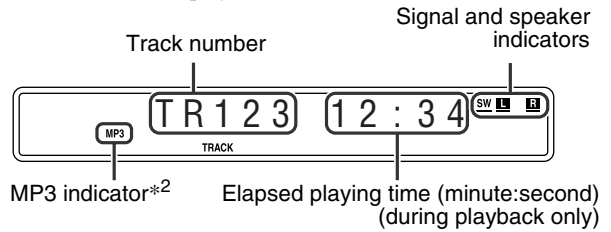

Pressing FL DISPLAY

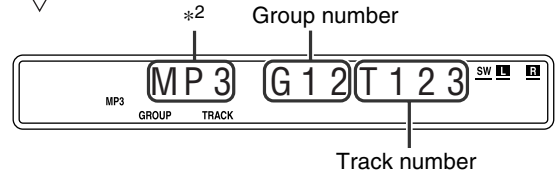

*2 WMA indicator lights for WMA disc.

JPEG disc

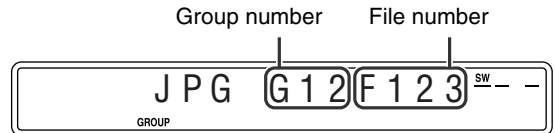

MPEG4 disc

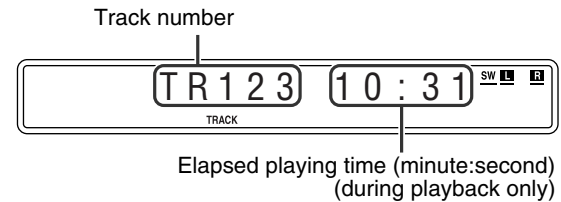

Pressing FL DISPLAY

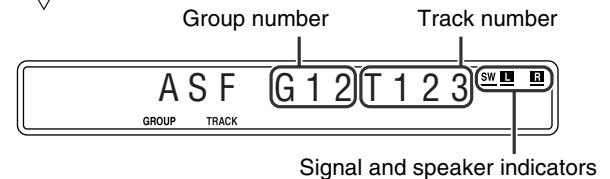

NOTE

- You can change the time information mode (except for MP3/WMA/JPEG/MPEG4). (pg. 28)
- You can also check the playback information on the TV screen. (pg. 27)

■ Disc information on the display window

The disc indicators on the display window show the current status of the corresponding disc tray.

Example:

When the discs are loaded to disc trays 1, 2 and 5, and the disc in the disc tray 5 is selected.

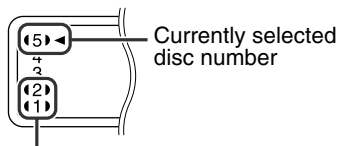

Currently loaded disc number

About the disc lamps (For TH-M606/TH-M603/TH-M505/TH-M501)

The disc lamps on the center unit also show the disc status. Only the disc lamp currently selected lights.

■ Screen saver

A TV screen may burn out if a static picture is displayed for a long time. To prevent this, the system automatically dims the screen if a static picture is displayed for over 5 minutes (the screen saver function).

- Pressing any button will cancel the screen saver function.
- If you do not want to use the screen saver function, see page 39.

One Touch Replay

You can move back the playback position by 10 seconds from the current position.



- During playback

On the remote control:

Press **↶**.

NOTE

- This function works in the same title.
- This feature may not work for some discs.

Fast-forward/fast-reverse search

- During playback



On the remote control:

Press **▶▶** or **◀◀**.

Each time you press the button, the search speed changes (×2, ×5, ×10, ×20, ×60).

To return to normal speed playback

Press **▶** (play button).

On the remote control and the center unit:

Press and hold **▶▶|** or **|◀◀**.

Continuously pressing **▶▶|** or **|◀◀** increases the fast-forward/reverse search speed (×5 → ×20).

NOTE

- The operation with **▶▶|** or **|◀◀** above is available for a disc other than MPEG4 disc.
- When a DVD VIDEO, VCD, SVCD, or MPEG4 disc is played back, no sound comes out during fast-forward/reverse search.
- When a DVD AUDIO or CD is played back, sound is intermittent and low during fast-forward/reverse search.
- This feature may not work for some discs.

Skip to the beginning of a desired selection

- Using **▶▶|/|◀◀** buttons



- For DVD VIDEO (chapter):
During playback
- For VCD/SVCD (track):
During playback without PBC function
- For DVD AUDIO/CD/MP3/WMA/JPEG/MPEG4 (track/file):
During playback or while stopped

Press **▶▶|** or **|◀◀** repeatedly.

NOTE

- When playing back an MP3/JPEG disc, you can make operations using the file control display. (☞ pg. 30)
- This feature may not work for some discs.

■ Using number buttons on the remote control

- For DVD VIDEO (title, chapter):
While stopped, the title number is selected.
During playback, the chapter number is selected.
- For DVD AUDIO (track):
During playback or while stopped
- For VCD/SVCD (track):
During playback without PBC function
- For CD/MP3/WMA/JPEG/MPEG4 (track/file):
During playback or while stopped

Press number buttons (0-10, +10) to select the desired number.

- For details on using the number buttons, see “How to use the number buttons” below.

How to use the number buttons

- To select 3: Press 3.
- To select 14: Press +10, then 4.
- To select 24: Press +10 twice, then 4.
- To select 40: Press +10 three times, then 10.
Or press +10 four times, then 0.

Locating a desired title/group using number buttons

- During playback or while stopped



1 Press TITLE/ GROUP.

“_ _” or “_” is shown in the title/group display area in the display window.

Example:
During DVD VIDEO playback

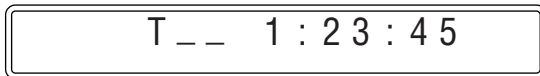

2 While the display window shows “_ _” or “_”, use number buttons (0-10, +10) to enter the desired title or group number.

The system starts playback from the first chapter/track/file of the selected title/group.

- For details on using the number buttons, see “How to use the number buttons” above.

NOTE

- This feature may not work for some discs.

Playing back a bonus group



Some DVD AUDIOS have a special group called “bonus group” whose contents are not open to the public. The bonus group is always assigned to the last group of a disc. To play back a bonus group, you have to enter the specific “key number” (a password). The way of getting the key number depends on the disc. After getting the key number, you can play back the bonus group by following the procedure below.

- While the BONUS indicator lights up on the display window

1 Select the bonus group.

For selecting the group, see “Locating a desired title/group using number buttons” described above.
The key number entry indication appears.

On the TV



On the display window

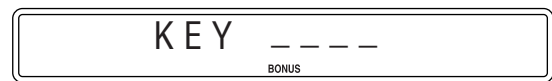

2 Press number buttons (0-9) to enter the key number, then press ENTER.

When you enter the correct key number, playback starts and the BONUS indicator goes off.

- If you enter the wrong number, reenter the correct number.

To clear the key number entry

Perform whichever one of the following:

- Press ■.
- Open the disc tray.
- Turn off the system.

NOTE

- If you specify a track in the bonus group for Program Playback, the key number entry indication in step 1 appears for entering the key number.
- In Random Playback, tracks in the bonus group are not played back.

Advanced operations

- The icon such as  shows the types of discs the operation is available for.

IMPORTANT

Before using the remote control for the following operation;

- Set the remote control mode selector to AUDIO.
 - Press DVD.
- There are exceptions in the operation mentioned above. In such a case, follow each instruction.

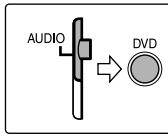

The buttons described below are used on pages 26 to 37.

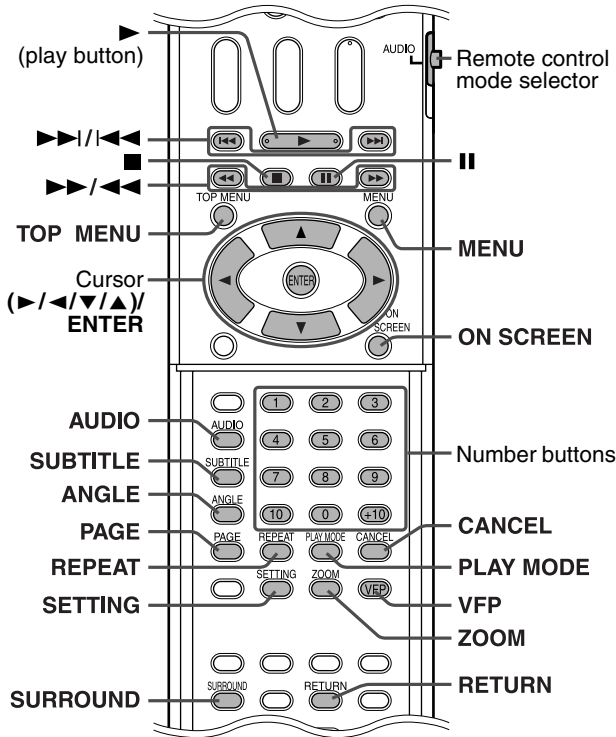

Using the surround mode

■ Auto Surround (AUTO SURR)

Used to reproduce the sound as it is recorded without any conversion (downmixing or simulation, etc.). For example, a multichannel source is automatically reproduced in multichannel audio.

■ Dolby Surround

Dolby Pro Logic II*¹

Dolby Pro Logic II has a newly developed multichannel playback format to decode all 2 channel sources — stereo source and Dolby Surround encoded source — into a 5.1 channel.

Dolby Pro Logic II has two modes — Movie mode and Music mode:

• Pro Logic II Movie (PL II MOVIE)

Suitable for reproduction of Dolby Surround encoded sources bearing the mark .

• Pro Logic II Music (PL II MUSIC)

Suitable for reproduction of any 2 channel stereo music sources.

■ Dolby Digital*¹

Used to reproduce multichannel soundtracks of the software encoded with Dolby Digital (.

■ DTS Digital Surround*²

Used to reproduce multichannel soundtracks of the software encoded with DTS Digital Surround (.

DTS Digital Surround (DTS) is another discrete multichannel digital audio format available on CD and DVD software.

Available Surround modes for each input signal

The √ marks show available surround modes.

| Mode | Surround off | Auto Surround | Dolby Surround | | | DTS Digital Surround | Linear PCM | Packed PCM | DSP |
|---|--------------|---------------|---------------------------|---------------------------|---------------|----------------------|------------|------------|--------------------------|
| | SURR OFF | AUTO SURR | PL II MOVIE* ³ | PL II MUSIC* ³ | Dolby Digital | DTS | LPCM | PPCM | ALL CH ST.* ³ |
| Dolby Digital (Multichannel) | √ | √ | — | — | √ | — | — | — | — |
| Dolby Digital (2 channel) | √ | √ | √ | √ | — | — | — | — | √ |
| DTS Digital Surround (Multichannel) | √ | √ | — | — | — | √ | — | — | — |
| DTS Digital Surround (2 channel) | √ | √ | √ | √ | — | — | — | — | √ |
| Analog (VCR) or Linear/Packed PCM (2 channel) | √ | √ | √ | √ | — | — | — | — | √ |
| Linear/Packed PCM (Multichannel) | √ | √ | — | — | — | — | √ | √ | — |

*¹ Manufactured under license from Dolby Laboratories. “Dolby”, “Pro Logic”, “MLP Lossless”, and the double-D symbol are trademarks of Dolby Laboratories.

*² “DTS” and “DTS Digital Surround” are registered trademarks of Digital Theater Systems, Inc.

*³ You can select these modes by pressing SURROUND. (pg. 27)

Continued on next page

■ All Channel Stereo (DSP)

All Channel Stereo (ALL CH ST.) mode can reproduce a larger stereo sound field using all the connected (and activated) speakers. All Channel Stereo can be used while reproducing 2 channel stereo source.

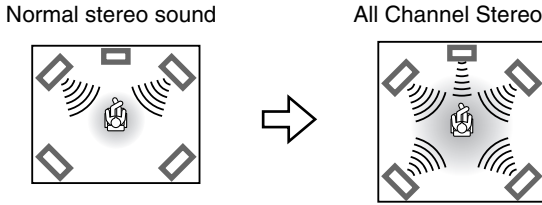

■ Indicators on the display window

Digital signal format indicators

- PPCM: Lights when DVD AUDIO packed PCM signals comes in.
- LPCM: Lights when Linear PCM signal comes in.
- DD: Lights when Dolby Digital signals come in.
- dts: Lights when DTS Digital (Surround) signals come in.
- No indication: No digital signal indicator lights when analog signals come in.

Dolby Surround/DSP mode indicators

- PLII: Lights when Dolby Pro Logic II mode is activated.
- DSP: Lights when All Channel Stereo mode is activated.

Source signal indicators, etc.

- Light to indicate the incoming signals.
- | | | | | |
|--|------------|-----------|----------|-----------|
| | SW | L | C | R |
| | LFE | LS | S | RS |
- L**: Lights when the left channel signal comes in.
 - C**: Lights when the center channel signal comes in.
 - R**: Lights when the right channel signal comes in.
 - LFE**: Lights when the LFE channel signal comes in.
 - LS**: Lights when the surround left channel signal comes in.
 - RS**: Lights when the surround right channel signal comes in.
 - S**: Lights when the monaural surround channel signal or 2 channel Dolby Surround signal comes in.
 - SW**: Always lights.

The channel with “—” shows that the corresponding speakers are reproducing the channels’ sound. If the channels’ sound decoded into 5.1 channel is reproduced, only “—” lights.

Selecting the surround mode

The system is set up to automatically select the optimal surround mode for input signal from digital multichannel software. When playing back 2 channel source, you can select the desired surround mode manually.

IMPORTANT

Before using the remote control for the following operation;

- Set the remote control mode selector to **AUDIO**.

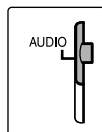

■ When playing back digital multichannel software (except during SURR OFF mode)

The appropriate multichannel surround mode (Dolby Digital, DTS Digital Surround or Linear/Packed PCM) is automatically selected.

■ When playing back 2 channel source

You can select either mode of Dolby Pro Logic II (PL II MOVIE/ PL II MUSIC) or the DSP (ALL CH ST.) mode.

Press SURROUND repeatedly to select the desired mode.

The surround mode is turned on and the current surround mode appears on the display window.

Each time you press the button, the surround mode changes.

For details on each mode, see page 26.

To turn off the surround mode

Press SURROUND repeatedly until SURR OFF appears on the display window.

Storing adjustments — auto memory

When you turn the power off, the system memorizes the current surround mode. The memorized mode is automatically recalled when you turn the power on.

NOTE

- When FM or AM is selected as the source, you cannot select any surround mode.
- For a down-mixing prohibited DVD AUDIO disc, the system continues to output multi-channel signals with “MULTI CH” shown on the display window even if the surround mode is turned off during playback. On the other hand, the system outputs only the front left and front right channel signals with “LR ONLY” shown on the display window when you start playback with the surround mode having been set to “SURR OFF”.

Using the on-screen bar

You can check disc information and you can use some functions using the on-screen bar.

Showing the on-screen bar

- Whenever a disc is loaded



Press ON SCREEN.

Each time you press the button, the on-screen bar changes as follows on the TV screen.

Example:

During DVD VIDEO playback



OFF
(The on-screen bar disappears)



(back to the beginning)

- The currently selected item shows green.

■ Contents of the on-screen bar during playback

DVD VIDEO

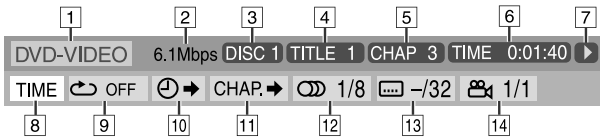

DVD AUDIO

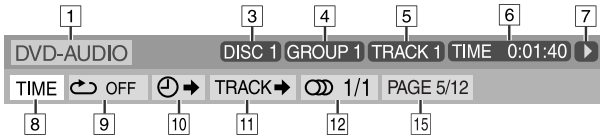

VCD

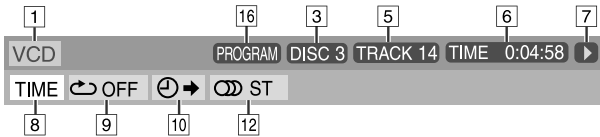

SVCD

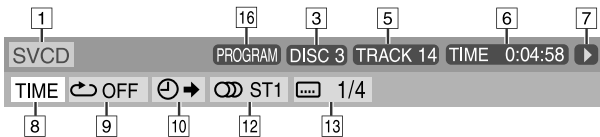

CD

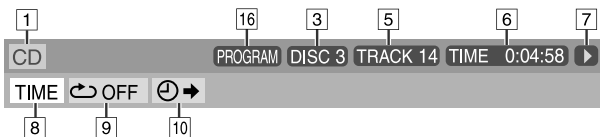

MPEG4*



* [8] - [15] are not available.

- [1] Shows disc type.
- [2] Shows current transfer rate (Megabits per second).
- [3] Shows disc number.
- [4] Shows current title (for DVD VIDEO) or group (for DVD AUDIO) number.
- [5] Shows current chapter number (for DVD VIDEO) or track number (for other type of discs).
- [6] Shows time information. See “Changing the time information” below.

- [7] Shows playback status.
 - [▶]: appears during playback.
 - [▶▶] / [◀◀]: appears during fast forward/reverse.
 - [▶] / [◀]: appears during playback in forward slow-motion/reverse slow-motion.
 - [⏸]: appears when paused.
 - [⏹]: appears when stopped.
- [8] Select this to change time information ([6]). See “Changing the time information” below.
- [9] Select this for Repeat Playback. (☞ pg. 35)
- [10] Select this for time search function. (☞ pg. 30)
- [11] Select this for chapter (for DVD VIDEO) or track (for DVD AUDIO) search function. (☞ pg. 29)
- [12] Select this to change audio language, channel, or stream. (☞ pg. 32)
- [13] Select this to change subtitle language. (☞ pg. 31)
- [14] Select this to change view angle. (☞ pg. 31)
- [15] Select this to change the page. (☞ pg. 33)
- [16] Shows Playback Mode status.
 - [PROGRAM]: appears during Program Playback. (☞ pg. 34)
 - [RANDOM]: appears during Random Playback. (☞ pg. 35)
- [17] Shows Repeat Mode status. (☞ pg. 35)

Changing the time information

You can change the time information in the on-screen bar on the TV screen and the display window of the center unit.



■ During playback

- 1 Press ON SCREEN twice.**
The on-screen bar appears on the TV screen.
- 2 Press Cursor ▶ / ◀ to highlight TIME .**
- 3 Press ENTER repeatedly to select the desired information.**

Example:

When elapsed playing time of disc is selected.

TOTAL 1:25:58

- TIME: Elapsed playing time of current chapter/track
- REM: Remaining time of current chapter/track
- TOTAL: Elapsed time of disc
- T. REM: Remaining time of disc

- 4 Press ON SCREEN.**

The on-screen bar disappears.

Playing from a specified position on a disc

You can start playing a title, chapter or track you specify. You can also play a disc from specified time.

Locating a desired scene from the DVD menu

DVD VIDEOS generally have their own menus which show disc contents and you can display them on the TV screen. You can locate a desired scene by using these menus.



- Whenever a DVD VIDEO is loaded

1 Press TOP MENU or MENU.

The menu appears on the TV screen.

Example:

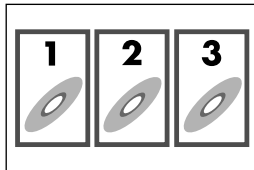

Normally, a DVD VIDEO which contains more than one title will have a "top" menu which lists the titles. Press TOP MENU to show the title menu.

Some DVD VIDEO may also have a different menu which is shown by pressing MENU.

See the instructions for each DVD VIDEO regarding its particular menu.

2 Use Cursor ►/◀/▼/▲ to select a desired item.

3 Press ENTER.

- With some discs, you can also select items by entering the corresponding number using number buttons.

Locating a desired scene using a VCD/SVCD menu with PBC

A VCD or SVCD recorded with PBC has its own menus such as a list of contained songs. You can locate a specific scene by using these menus.



- During playback with PBC function

1 Press RETURN repeatedly until the menu appears on the TV screen.

Example:

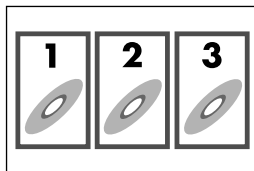

2 Press number buttons (1-10, +10) to select the number of the desired item.

- For details on using the number buttons, see "How to use the number buttons" (pg. 25).

To return to the menu

Press RETURN.

When "NEXT" or "PREVIOUS" is shown on the TV screen:

- To go to the next page, press ►►.
- To return to the previous page, press ◀◀.

NOTE

- If you want to play a PBC-compatible VCD/SVCD without using the PBC function, perform any of the following:
 - Start playback by pressing number buttons while stopped.
 - Press ►► repeatedly until the desired track number is displayed, then start playback by pressing ► (play button). The track number appears on the display window instead of "PBC".
- To activate the PBC function when playing a PBC-compatible VCD/SVCD without using the PBC function, perform any of the following:
 - Press TOP MENU or MENU.
 - Press ■ twice to stop playback, then press ► (play button).

Locating a desired chapter/track using the on-screen bar

- During playback

1 Press ON SCREEN twice.

The on-screen bar appears on the TV screen.

2 Press Cursor ►/◀ to highlight CHAP.►/ TRACK►.

3 Press ENTER.

Example:

During DVD VIDEO playback



4 Press number buttons (0-9) to enter the desired chapter number.

Example:

- To select 8: Press 8.
- To select 10: Press 1, then 0.
- To select 20: Press 2, then 0.
- To select 37: Press 3, then 7.

To correct a misentry

Repeat step 4.

5 Press ENTER.

6 Press ON SCREEN.

The on-screen bar disappears.

NOTE

- You can select up to the 99th chapter/track.

Locating a desired position by specifying the time

- For DVD VIDEO/DVD AUDIO:  During playback
- For VCD/SVCD: While stopped or during playback without PBC function
- For CD: During playback or while stopped

■ When specifying the elapsed playing time from the beginning of the disc

Perform the following procedure while stopped.

■ When specifying the elapsed playing time from the beginning of the current title/track

Perform the following procedure during playback.

1 Press ON SCREEN twice.

The on-screen bar appears on the TV screen.

2 Press Cursor ►/◄ to highlight ⏪⏩.

3 Press ENTER.



4 Use number buttons (0-9) to enter the time.

Example:

To play back from a point 2 (hours): 34 (minutes): 08 (seconds) elapsed

TIME _:__:__ ⇒ TIME 2:__:__ ⇒
Press 2 Press 3

TIME 2:3_:__ ⇒ TIME 2:34:__ ⇒
Press 4 Press 0

TIME 2:34:0_ ⇒ TIME 2:34:08
Press 8

To cancel a misentry

Press Cursor ◀ repeatedly.

5 Press ENTER.

6 Press ON SCREEN.

The on-screen bar disappears.

NOTE

- You can specify time in hours/minutes/seconds for DVD VIDEO/DVD AUDIO and in minutes/seconds for VCD/SVCD/CD.

Using the file control display

You can search and play desired groups and tracks/files using the file control display on the TV screen.



Current group /total group Playback mode (PROGRAM, RANDOM, REPEAT)

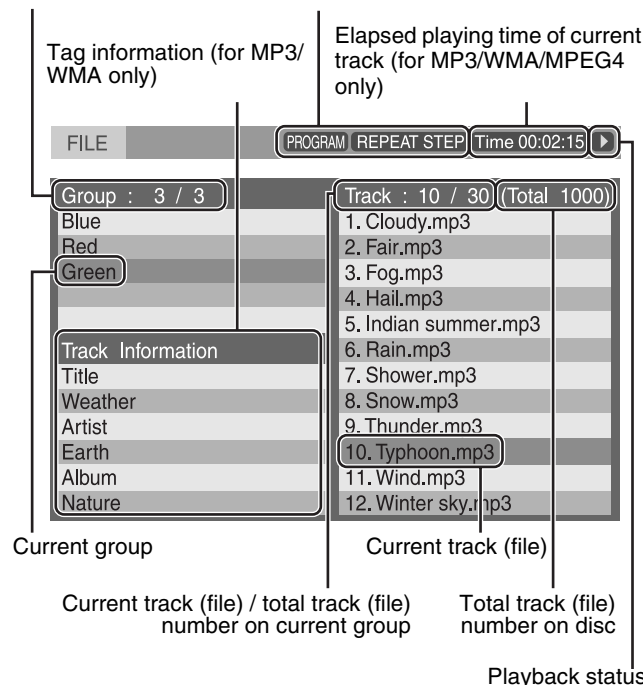

The file control display appears automatically during playback (MP3/WMA) or while stopped.

- For MP3/WMA:
During playback or while stopped
- For JPEG/MPEG4:
While stopped

1 Press Cursor ▶/◀/▼/▲ to select the desired group/track/file.

- For MP3/WMA, playback starts from the selected track.

2 Press ▶ (play button) or ENTER.

- Track playback/slide-show starts from the selected track/file.
- When you press ENTER for JPEG, only the selected file is played back.

NOTE

- During playback, you can locate the desired track/file by pressing ▶▶/◀◀ or Cursor ▲/▼.
- You can also check playback information on the display window. (☞ pg. 23)
- Some group, track and file names may not be displayed correctly depending on recording conditions.
- The order of groups, tracks and files may be displayed differently from the order displayed on your personal computer.

Resume Playback

When Resume Playback is set to “ON” (☞ pg. 40) and you stop playback by the following operations, the position where playback has been stopped is stored. (“RESUME” appears on the display window.)



- Turning off the power (☞ pg. 18)
- Pressing ■ once
- Changing the source (☞ pg. 19)

To start playback from the stored position

Press ▶ (play button) or DVD.

- There may be a case where ▶ (play button) does not work after changing the source.

To clear the stored position

Press ■ again or open the disc tray with the playback disc.

Selecting a view angle

- During playback of a disc containing multi-view angles



When using the ANGLE button:

1 Press ANGLE.

Example:

The first view angle is selected out of 3 view angles recorded.

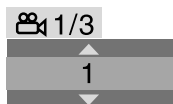

2 Press ANGLE repeatedly or press Cursor ▼/▲ to select the desired view angle.

When using the on-screen bar:

1 Press ON SCREEN twice.

The on-screen bar appears on the TV screen.

2 Press Cursor ▶/◀ to highlight 1/3.

3 Press ENTER.

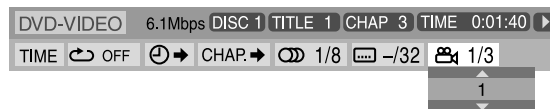

4 Press Cursor ▼/▲ to select the desired view angle.

5 Press ENTER.

6 Press ON SCREEN.

The on-screen bar disappears.

NOTE

- During DVD AUDIO playback, this feature is available only for the video part.

Selecting the subtitle

- During playback of a disc containing subtitles in several languages



When using the SUBTITLE button:

1 Press SUBTITLE.

Example (DVD VIDEO):

“ENGLISH” is selected out of 3 subtitle languages recorded.

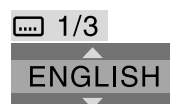

- Each time you press SUBTITLE, subtitle appears and disappears alternately.

2 Press Cursor ▼/▲ to select the desired subtitle.

For SVCD

- An SVCD can contain up to four subtitles. Pressing SUBTITLE changes the subtitles regardless of whether the subtitles are recorded or not. (Subtitles will not change if no subtitle is recorded.)

When using the on-screen bar:

- 1 Press ON SCREEN twice.**
The on-screen bar appears on the TV screen.
- 2 Press Cursor ►/◄ to highlight**  1/3 .
- 3 Press ENTER.**



- 4 Press Cursor ▼/▲ repeatedly to select the desired subtitle.**
- 5 Press ENTER.**
- 6 Press ON SCREEN.**
The on-screen bar disappears.

NOTE

- Some subtitle or audio languages are abbreviated in the pop-up window. See “The language codes list” (☞ pg. 38).
- During DVD AUDIO playback, this feature is available only for the video part.

Selecting the audio

- During playback of a disc containing audio in several languages



When using the AUDIO button:

- 1 Press AUDIO.**
Example (DVD VIDEO):
“ENGLISH” is selected out of 3 audio languages recorded.

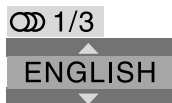

- 2 Press AUDIO repeatedly or press Cursor ▼/▲ to select the desired audio.**

When using the on-screen bar:

- 1 Press ON SCREEN twice.**
The on-screen bar appears on the TV screen.
- 2 Press Cursor ►/◄ to highlight**  1/3 .
- 3 Press ENTER.**

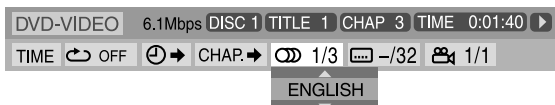

- 4 Press Cursor ▼/▲ to select the desired audio.**
- 5 Press ENTER.**
- 6 Press ON SCREEN.**
The on-screen bar disappears.

NOTE

- Some subtitle or audio languages are abbreviated in the pop-up window. See “The language codes list” (☞ pg. 38).
- “ST”, “L” or “R” is displayed when playing a VCD or SVCD respectively representing “stereo”, “left sound” and “right sound”.

Special picture playback

Frame-by-frame playback

- During playback

Press II repeatedly.



Each time you press the button, the still picture advances by one frame.

To return to normal playback

Press ► (play button).

NOTE

- During DVD AUDIO playback, this feature is available only for the video part.

Playing back in slow-motion

- During playback

1 Press II at the point where you want to start playback in slow-motion from.



The system pauses playback.

2 Press ►►.

- Playback in forward slow-motion starts.

For DVD VIDEO/DVD AUDIO only:

- To play back in reverse slow-motion, press ◄◄.

Each time you press the button, the playback speed become faster.

Example: On the TV



To return to normal playback

Press ► (play button).

NOTE

- Sound cannot be heard during slow-motion playback.
- During DVD AUDIO playback, this feature is available only for the video part.

Selecting browsable still picture recorded on DVD AUDIO

Most DVD AUDIOS include browsable still pictures (B.S.P.), which usually appear by turns automatically during playback according to the playback sequence. You can change the picture (turn the page) manually when the current group/track has selectable pictures (pages).



- During playback and while the B.S.P. indicator lights up on the display window

When using the PAGE button:

Press PAGE repeatedly to select a desired still picture.

When using the on-screen bar:

1 Press ON SCREEN twice.

The on-screen bar appears on the TV screen.

2 Press Cursor ►/◀ to highlight PAGE .

3 Press ENTER.

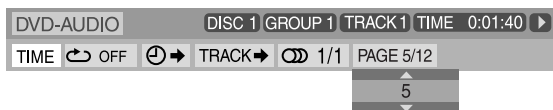

4 Press Cursor ▲/▼ to select the desired still picture.

5 Press ENTER.

6 Press ON SCREEN.

The on-screen bar disappears.

Zooming in

- During playback or while paused



1 Press ZOOM.

Each time you press ZOOM, scene magnification changes.

2 While zoomed in, press Cursor ►/◀/▼/▲ to move zoom-in area.

To return to normal playback

Press ZOOM repeatedly to select ZOOM OFF.

NOTE

- The number of the magnification steps varies depending on the disc type.
- During slide-show playback of a JPEG disc, zooming in is not available. In such a case, press **II** to pause slide-show playback, then zoom in.
- During DVD AUDIO playback, this feature is available only for the video part.
- During MPEG4 playback, there may be a case where Cursor ►/◀/▼/▲ does not work in step 2 above.

Changing the VFP setting

The VFP (Video Fine Processor) function enables you to adjust



the picture character according to the type of programming, picture tone or personal preference.

- During playback

1 Press VFP.

The current VFP settings appear on the TV screen.

Example:

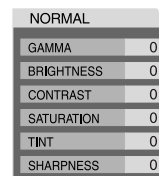

2 Press Cursor ►/◀ repeatedly to select the VFP mode.

- NORMAL: Normally select this.
- CINEMA: Suitable for movies.

When you select "NORMAL" or "CINEMA", press VFP to complete the setting.

- USER 1 and USER 2:

You can adjust parameters that affect picture appearance.

Only when selecting "USER 1" or "USER 2" in step 2, proceed to perform the following operation;

3 Press Cursor ▼/▲ repeatedly to select a parameter you want to adjust.

Adjust gradually and confirm picture appearance results are as preferred.

- GAMMA: Controls brightness of neutral tints while maintaining brightness of dark and bright portions.
- BRIGHTNESS: Controls screen brightness.
- CONTRAST: Controls screen contrast.
- SATURATION: Controls screen color depth.
- TINT: Controls screen tint.
- SHARPNESS: Controls screen sharpness.

4 Press ENTER.

Example:



5 Press Cursor ▼/▲ to change the setting.

6 Press ENTER.

The current VFP settings appear again.

7 Repeat steps 3 to 6 to adjust other parameters.

8 Press VFP.

NOTE

- Although the setting display disappears in the middle of the procedure, the setting at that time will be stored.

Program Playback

■ While stopped



1 Press PLAY MODE repeatedly until program window appears on the TV screen.

| PROGRAM | | | |
|---------|------|-------------|---------------|
| No. | Disc | Group/Title | Track/Chapter |
| 1 | | | |
| 2 | | | |
| 3 | | | |
| 4 | | | |
| 5 | | | |
| 6 | | | |
| 7 | | | |
| 8 | | | |
| 9 | | | |
| 10 | | | |

USE NUMERIC KEYS TO PROGRAM TRACKS.
USE CANCEL TO DELETE THE PROGRAM.

2 Follow the instructions that appears on the TV screen to program the desired chapters/ tracks.

- For details on using the number buttons, see “How to use the number buttons” (pg. 25).
- The content’s numbers that you have to specify for programming varies depending on the disc type:
 - DVD VIDEO: Titles and chapters
 - VCD, SVCD, CD: Tracks
 - DVD AUDIO, MP3, WMA: Groups and tracks
- Before you program the tracks in bonus group on a DVD AUDIO, perform the procedure of “Playing back a bonus group” (pg. 25) to turn off the BONUS indicator on the display window.
- You can specify the chapters/tracks whose number is up to 99.

To clear the programs one by one from the last entered number

Press CANCEL repeatedly.

To clear all programs

Press ■.

You can also clear the program by turning off the system.

3 Press ► (play button).

If all of the programmed tracks/files have been played back, playback stops and the program window appears again. Note that program setting remains.

To check the program contents

During playback, press ■. Playback stops and the program window appears.

To quit the Program mode

While stopped, press PLAY MODE repeatedly until both program window and RANDOM disappear from the TV screen.

NOTE

- There may be a case where bonus group on a DVD AUDIO cannot be played.
- The Resume function cannot be used with Program Playback.
- Program Playback may not work for some discs.

Random Playback

You can play titles or tracks on a disc in random order.



■ While stopped

1 Press **PLAY MODE** repeatedly until **RANDOM** appears on the TV screen.

2 Press **▶** (play button).

- When more than one discs are loaded, the system starts Random Playback of the next disc after completing current disc playback.

To quit Random mode

While stopped, press **PLAY MODE** repeatedly until both program window and **RANDOM** disappear from the TV screen. You can also clear the Random mode by turning off the system.

NOTE

- The same title/track will not be played back more than once during Random Playback.

Repeat Playback

Repeating the current selection or all discs

- For DVD VIDEO: During playback
- For DVD AUDIO: During playback without PBC function or stopped
- For VCD/SVCD: During playback or stopped
- For CD: During playback or stopped
- For MP3/WMA: During playback or stopped
- For JPEG/MPEG4: During playback or stopped



When using the **REPEAT** button: Press **REPEAT**.

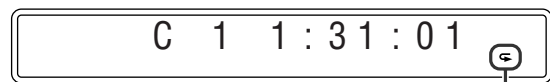

Repeat mode indicator

Each time you press **REPEAT**, the Repeat mode changes.

| Display window | TV screen | Meanings |
|----------------|---------------|--|
| ↻ | ↻GROUP | Repeats the current group for DVD AUDIO/MP3/WMA/JPEG/MPEG4 disc. |
| | REPEAT GROUP* | |
| | ↻TITLE | Repeats the current title for DVD VIDEO. |
| | ↻DISC | Repeats all tracks on the current disc for VCD/SVCD/CD/MP3/WMA/JPEG/MPEG4. |
| REPEAT DISC* | | |
| ↻ ALL | ↻ALL | Repeats all the available discs. |
| | REPEAT ALL* | |
| ↻ 1 | ↻TRACK | Repeats the current track for DVD AUDIO/VCD/SVCD/CD/MP3/WMA/MPEG4 disc. |
| | REPEAT TRACK | |
| | ↻CHAP | Repeats the current chapter for DVD VIDEO. |
| No indication | ↻OFF | Repeat mode is off. The system plays back all available discs normally. |

* During playback of a JPEG disc, “REPEAT GROUP”, “REPEAT DISC” and “REPEAT ALL” do not appear on the TV screen.

NOTE

- When the Program mode is active with a DVD AUDIO, VCD, SVCD, or CD, the Repeat mode changes in the same manner. Note that, however, in the “↻” mode the system repeats all the programmed tracks, instead of all tracks on the disc.

When using the on-screen bar (except for MP3/WMA/JPEG/MPEG4 disc):

1 Press **ON SCREEN** twice.

The on-screen bar appears on the TV screen.

2 Press **Cursor ▶/◀** to highlight **↻ OFF**.

3 Press **ENTER**.

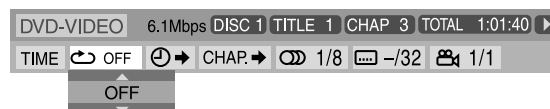

4 Press **Cursor ▼/▲** repeatedly to select the Repeat mode.

5 Press **ENTER**.

6 Press **ON SCREEN**.

The on-screen bar disappears.

To cancel Repeat Playback

Select “OFF” in step 4.

Repeating a desired part [A-B Repeat]

You can repeat playback of a desired part by specifying the beginning (point A) and ending (point B).



■ During playback

1 Press ON SCREEN twice.

The on-screen bar appears on the TV screen.

2 Press Cursor ►/◄ to highlight OFF .

3 Press ENTER.



4 Press Cursor ▼/▲ repeatedly to select "A-B".

5 Press ENTER at the beginning of the part you want to repeat (point A).



6 Press ENTER at the end of the part you want to repeat (point B).

A-B Repeat Playback starts.

7 Press ON SCREEN.

The on-screen bar disappears.

To cancel

Select "OFF" in step 4, then press ENTER.

NOTE

- When playing back a DVD VIDEO, A-B Repeat Playback is possible only within the same title.
- "A-B" cannot be selected during Program and Random Playback.

Tray lock

You can lock trays and prohibit the unwanted disc ejection.

On the center unit ONLY:

While the system is turned off

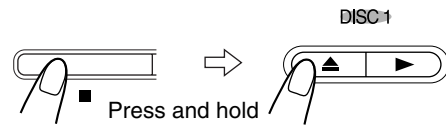

- The system turns on and "LOCKED" appears on the display window.
- If you try to eject discs, "LOCKED" appears to indicate that trays are locked.

To cancel

Carry out the same operation again.

- The system turns on and "UNLOCKED" appears on the display window.

Sound and other settings

IMPORTANT

Before using the remote control for the following operation;

- Set the remote control mode selector to AUDIO.

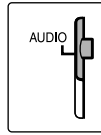

NOTE

Before you start operation;

- There is a time limit when doing the following steps. If the setting is cancelled before you finish, start from step 1 again.

1 Press SETTING.

Example:



2 Press Cursor ▼/▲ to select the item you want to set.

- BAL (Balance):
You can adjust the balance between the front left and front right speakers.
- DEC (Decode):
When you play an external source (DBS is selected as a source) that was encoded with Dolby Digital or DTS Digital Surround, the following symptoms may occur;
 - No sound comes out at the beginning of playback.
 - Noise comes out while searching for or skipping chapters or tracks.

AUT/PCM (Auto/PCM):

Normally select this. The system automatically detects the incoming signals.

DOLBY D: Select this if the symptoms above occur when playing a disc (or software) encoded with Dolby Digital.

DTS: Select this if the symptoms above occur when playing a disc (or software) encoded with DTS Digital Surround.

- M. OUT (Monitor Out):
Select the video output jack type by which you watch DVD playback after connecting your TV. (☞ pg. 14)
Set the video output to use AV COMPU LINK remote control system. (☞ pg. 44)

VIDEO: To watch DVD playback via the VIDEO jack.

S: To watch DVD playback via the S-VIDEO jack.

COMPNT (component):

To watch DVD playback via the COMPONENT VIDEO OUT jacks.

- DiscIII (For TH-M606/TH-M603/TH-M505/TH-M501):
When you select DVD as the source and leave the system in stop mode for 5 minutes, the disc lamps starts illuminating.

3 Press Cursor ►/◀ to make an adjustment or selection.

Example:

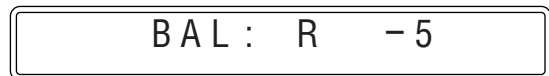

The adjustment is set and display automatically disappears a few seconds later.

NOTE

- When "DOLBY D" or "DTS" is selected, if a signal encoded with another digital format comes in, you cannot listen to the sound. (The DIGITAL or DTS indicator flashes.)

Setting DVD preferences

Using the setup menus

- You can change the language used in the setup menus. See “Menu description” below.

Basic operation on the setup menus

IMPORTANT

Before using the remote control for the following operation;

- Set the remote control mode selector to AUDIO.
- Press DVD.

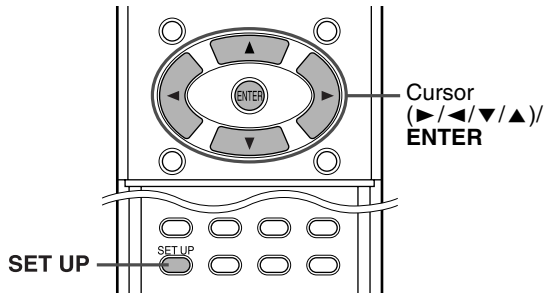
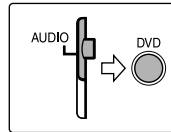

- While stopped

1 Press SET UP.

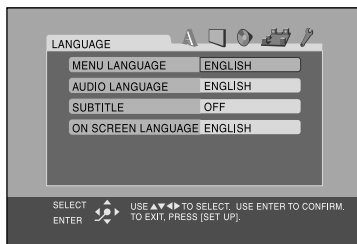

2 Follow the instructions that appears on the TV screen.

Menu description

A: Language menu (LANGUAGE)

■ MENU LANGUAGE

Some DVDs have their own menus in multiple languages.

- Select the initial language*.

■ AUDIO LANGUAGE

Some DVDs have multiple audio languages.

- Select the initial audio language*.

■ SUBTITLE

Some DVDs have multiple subtitle languages.

- Select the initial subtitle language*.

■ ON SCREEN LANGUAGE

- Select the language shown on the TV screen when operating this system.

* When the language you have selected is not recorded to a disc, the original language is automatically used as the initial language.

NOTE

- See the following “The language codes list” for the codes of each language, such as “AA”, etc.

The language codes list

| | | | | | |
|----|-----------------|----|------------------|----|----------------|
| AA | Afar | IK | Inupiak | RN | Kirundi |
| AB | Abkhazian | IN | Indonesian | RO | Rumanian |
| AF | Afrikaans | IS | Icelandic | RU | Russian |
| AM | Ameharic | IW | Hebrew | RW | Kinyarwanda |
| AR | Arabic | JI | Yiddish | SA | Sanskrit |
| AS | Assamese | JW | Javanese | SD | Sindhi |
| AY | Aymara | KA | Georgian | SG | Sangho |
| AZ | Azerbaijani | KK | Kazakh | SH | Serbo-Croatian |
| BA | Bashkir | KL | Greenlandic | SI | Singhalese |
| BE | Byelorussian | KM | Cambodian | SK | Slovak |
| BG | Bulgarian | KN | Kannada | SL | Slovenian |
| BH | Bihari | KO | Korean (KOR) | SM | Samoan |
| BI | Bislama | KS | Kashmiri | SN | Shona |
| BN | Bengali, Bangla | KU | Kurdish | SO | Somali |
| BO | Tibetan | KY | Kirghiz | SQ | Albanian |
| BR | Breton | LA | Latin | SR | Serbian |
| CA | Catalan | LN | Lingala | SS | Siswati |
| CO | Corsican | LO | Laothian | ST | Sesotho |
| CS | Czech | LT | Lithuanian | SU | Sundanese |
| CY | Welsh | LV | Latvian, Lettish | SV | Swedish |
| DA | Danish | MG | Malagasy | SW | Swahili |
| DZ | Bhutani | MI | Maori | TA | Tamil |
| EL | Greek | MK | Macedonian | TE | Telugu |
| EO | Esperanto | ML | Malayalam | TG | Tajik |
| ET | Estonian | MN | Mongolian | TH | Thai |
| EU | Basque | MO | Moldavian | TI | Tigrinya |
| FA | Persian | MR | Marathi | TK | Turkmen |
| FI | Finnish | MS | Malay (MAY) | TL | Tagalog |
| FJ | Fiji | MT | Maltese | TN | Setswana |
| FO | Faroese | MY | Burmese | TO | Tonga |
| FY | Frisian | NA | Nauru | TR | Turkish |
| GA | Irish | NE | Nepali | TS | Tsonga |
| GD | Scots Gaelic | NL | Dutch | TT | Tatar |
| GL | Galician | NO | Norwegian | TW | Twi |
| GN | Guarani | OC | Occitan | UK | Ukrainian |
| GU | Gujarati | OM | (Afan) Oromo | UR | Urdu |
| HA | Hausa | OR | Oriya | UZ | Uzbek |
| HI | Hindi | PA | Panjabi | VI | Vietnamese |
| HR | Croatian | PL | Polish | VO | Volapuk |
| HU | Hungarian | PS | Pashto, Pushto | WO | Wolof |
| HY | Armenian | PT | Portuguese | XH | Xhosa |
| IA | Interlingua | QU | Quechua | YO | Yoruba |
| IE | Interlingue | RM | Rhaeto-Romance | ZU | Zulu |

Picture menu (PICTURE)

■ MONITOR TYPE

You can select the monitor type to match your TV when you play DVDs recorded in the picture's height/width ratio of 16:9.

- **16:9 (Wide television conversion)**
Select this when the aspect ratio of your TV is 16:9 (wide TV).
- **4:3 LB (Letter Box conversion)**
Select this when the aspect ratio of your TV is 4:3 (conventional TV). While viewing a wide screen picture, the black bars appear on the top and the bottom of the screen.
- **4:3 PS (Pan Scan conversion)**
Select this when the aspect ratio of your TV is 4:3 (conventional TV). While viewing a wide screen picture, the black bars do not appear, however, the left and right edges of the pictures will not be shown on the screen.



Ex.: 16:9



Ex.: 4:3 LB



Ex.: 4:3 PS

NOTE

- Even if "4:3 PS" is selected, the screen size may become "4:3 LB" with some DVDs. This depends on how DVDs are recorded.

■ PICTURE SOURCE

When you set the scan mode to PROGRESSIVE (☞ pg. 20), you can obtain optimal picture quality by selecting whether the content on the disc is processed by field (video source) or by frame (film source).

Normally set to "AUTO".

- **AUTO**
Used to play a disc containing both video and film source materials.
This system recognizes the source type (video or film) of the current disc according to the disc information.
- If the playback picture is unclear or noisy, or the oblique lines of the picture are rough, try to change to other modes.
- **FILM**
Suitable for playing back a film source disc.
- **VIDEO**
Suitable for playing back a video source disc.

■ SCREEN SAVER (☞ pg. 24)

You can activate or deactivate Screen Saver function.

■ FILE TYPE

When several types of files are recorded on a disc, you can select which files to play. If you have changed FILE TYPE setting, be sure to turn the power off, then turn the power on to enable the new setting.

- **AUDIO**
Select this to play MP3/WMA files.
- **STILL PICTURE**
Select this to play JPEG files.
- **VIDEO**
Select this to play MPEG4 files.

Audio menu (AUDIO)

■ D. RANGE COMPRESSION

(Dynamic range compression)

You can enjoy low level recorded sound clearly at night even at a low volume when listening to the sound with Dolby Digital.

- **AUTO**
Select this when you want to enjoy surround sound with its full dynamic range (no effect applied).
- **ON**
Select this when you want to fully apply the compression effect (useful at midnight).

NOTE

- When you play a multichannel Dolby Digital source with the surround mode is off, the setting of D. RANGE COMPRESSION is set to ON automatically.

Speaker setting menu (SPK. SETTING)

■ Level menu (LEVEL)

CENTER SPEAKER/SURROUND RIGHT SPEAKER/ SURROUND LEFT SPEAKER/SUBWOOFER

While monitoring the test tone, adjust the center and surround speakers volume as much as that of the front speakers.

TEST TONE*

Outputs the test tone.

RETURN

Returns to the SPK. SETTING menu.

- * The test tone comes out of all of the activated speakers in the following sequence:

⇒ Front left speaker ⇒ Center speaker ⇒ Front right speaker ⇒ Surround right speaker ⇒ Surround left speaker ⇒ (back to the beginning)

NOTE

- Before you turn on the test tone, be sure to select AUTO SURR as the surround mode. (☞ pg. 26)

Setting DVD preferences

■ Distance menu (DISTANCE)

Example:

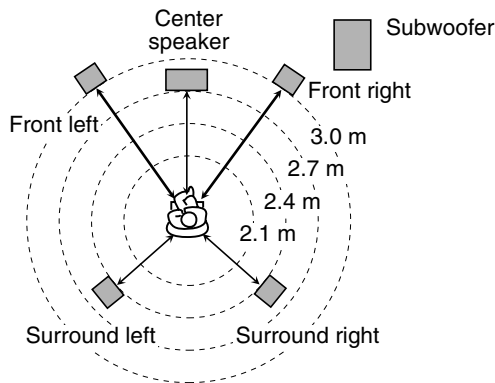

In this case, set the distance of each speaker as follows;

- Distance of front speakers: 3.0 m/10 ft
- Distance of center speaker: 2.7 m/9 ft
- Distance of surround speakers: 2.4 m/8 ft

FRONT SPEAKER/CENTER SPEAKER/SURROUND SPEAKER

Adjust the distance from the listening position to the speakers.

Within the range from 0.3 m/1 ft to 9.0 m/30 ft. (by 0.3 m/1 ft)

RETURN

Returns to the **SPK. SETTING** menu.



Other setting menu (OTHERS)

■ RESUME

You can activate or deactivate Resume Playback function.

(pg. 31)

■ ON SCREEN GUIDE

You can activate or deactivate the on-screen guide icons.

(pg. 22)

■ Parental lock menu (PARENTAL LOCK)

You can restrict playback of a DVD VIDEO containing violent scenes that is not suitable for your other family members.

- This setting takes effect only for DVDs containing the Parental Lock level information — Level 1 (most restrictive) to Level 8 (least restrictive).

COUNTRY CODE

Select this when you set the code for your resident.

(pg. 41)

SET LEVEL

Select this when you set the level of restriction.

PASSWORD

This item is selected automatically when some changes are made on Parental Lock setting. Enter a four-digit number as your password with number buttons 0-9, then press **ENTER**.

- If you have failed to enter your correct password three times, you cannot select an item other than EXIT. In such a case, press **ENTER** to exit the mode, then try the setting again.

EXIT

Returns to **OTHERS** menu.

- Be sure to exit the Parental Lock setting mode after entering your password. Otherwise, the changes you made won't be stored.
- If you forget your password, enter "8888" instead of your password.

NOTE

- When you enter wrong passwords three times, you can only select EXIT.

Country/Area codes list for Parental Lock

| | | | | | | | |
|----|--------------------------|----|--|----|----------------------------------|----|--------------------------------------|
| AD | Andorra | ER | Eritrea | LA | Lao People's Democratic Republic | RW | Rwanda |
| AE | United Arab Emirates | ES | Spain | LB | Lebanon | SA | Saudi Arabia |
| AF | Afghanistan | ET | Ethiopia | LC | Saint Lucia | SB | Solomon Islands |
| AG | Antigua and Barbuda | FI | Finland | LI | Liechtenstein | SC | Seychelles |
| AI | Anguilla | FJ | Fiji | LK | Sri Lanka | SD | Sudan |
| AL | Albania | FK | Falkland Islands (Malvinas) | LR | Liberia | SE | Sweden |
| AM | Armenia | FM | Micronesia (Federated States of) | LS | Lesotho | SG | Singapore |
| AN | Netherlands Antilles | | | LT | Lithuania | SH | Saint Helena |
| AO | Angola | FO | Faroe Islands | LU | Luxembourg | SI | Slovenia |
| AQ | Antarctica | FR | France | LV | Latvia | SJ | Svalbard and Jan Mayen |
| AR | Argentina | FX | France, Metropolitan | LY | Libyan Arab Jamahiriya | SK | Slovakia |
| AS | American Samoa | GA | Gabon | MA | Morocco | SL | Sierra Leone |
| AT | Austria | GB | United Kingdom | MC | Monaco | SM | San Marino |
| AU | Australia | GD | Grenada | MD | Moldova, Republic of | SN | Senegal |
| AW | Aruba | GE | Georgia | MG | Madagascar | SO | Somalia |
| AZ | Azerbaijan | GF | French Guiana | MH | Marshall Islands | SR | Suriname |
| BA | Bosnia and Herzegovina | GH | Ghana | ML | Mali | ST | Sao Tome and Principe |
| BB | Barbados | GI | Gibraltar | MM | Myanmar | SV | El Salvador |
| BD | Bangladesh | GL | Greenland | MN | Mongolia | SY | Syrian Arab Republic |
| BE | Belgium | GM | Gambia | MO | Macau | SZ | Swaziland |
| BF | Burkina Faso | GN | Guinea | MP | Northern Mariana Islands | TC | Turks and Caicos Islands |
| BG | Bulgaria | GQ | Equatorial Guinea | MQ | Martinique | TD | Chad |
| BH | Bahrain | GR | Greece | MR | Mauritania | TF | French Southern Territories |
| BI | Burundi | GS | South Georgia and the South Sandwich Islands | MS | Montserrat | TG | Togo |
| BJ | Benin | | | MT | Malta | TH | Thailand Code Language |
| BM | Bermuda | GT | Guatemala | MU | Mauritius | TJ | Tajikistan |
| BN | Brunei Darussalam | GU | Guam | MV | Maldives | TK | Tokelau |
| BO | Bolivia | GW | Guinea-Bissau | MW | Malawi | TM | Turkmenistan |
| BR | Brazil | GY | Guyana | MX | Mexico | TN | Tunisia |
| BS | Bahamas | HK | Hong Kong | MY | Malaysia | TO | Tonga |
| BT | Bhutan | HM | Heard Island and McDonald Islands | MZ | Mozambique | TP | East Timor |
| BV | Bouvet Island | | | NA | Namibia | TR | Turkey |
| BW | Botswana | HN | Honduras | NC | New Caledonia | TT | Trinidad and Tobago |
| BY | Belarus | HR | Croatia | NE | Niger | TV | Tuvalu |
| BZ | Belize | HT | Haiti | NF | Norfolk Island | TW | Taiwan |
| CA | Canada | HU | Hungary | NG | Nigeria | TZ | Tanzania, United Republic of |
| CC | Cocos (Keeling) Islands | ID | Indonesia | NI | Nicaragua | UA | Ukraine |
| CF | Central African Republic | IE | Ireland | NL | Netherlands | UG | Uganda |
| CG | Congo | IL | Israel | NO | Norway | UM | United States Minor Outlying Islands |
| CH | Switzerland | IN | India | NP | Nepal | | |
| CI | Côte d'Ivoire | IO | British Indian Ocean Territory | NR | Nauru | US | United States |
| CK | Cook Islands | IQ | Iraq | NU | Niue | UY | Uruguay |
| CL | Chile | IR | Iran (Islamic Republic of) | NZ | New Zealand | UZ | Uzbekistan |
| CM | Cameroon | IS | Iceland | OM | Oman | VA | Vatican City State (Holy See) |
| CN | China | IT | Italy | PA | Panama | VC | Saint Vincent and the Grenadines |
| CO | Colombia | JM | Jamaica | PE | Peru | | |
| CR | Costa Rica | JO | Jordan | PF | French Polynesia | VE | Venezuela |
| CU | Cuba | JP | Japan | PG | Papua New Guinea | VG | Virgin Islands (British) |
| CV | Cape Verde | KE | Kenya | PH | Philippines | VI | Virgin Islands (U.S.) |
| CX | Christmas Island | KG | Kyrgyzstan | PK | Pakistan | VN | Vietnam |
| CY | Cyprus | KH | Cambodia | PL | Poland | VU | Vanuatu |
| CZ | Czech Republic | KI | Kiribati | PN | Pitcairn | WF | Wallis and Futuna Islands |
| DE | Germany | KN | Saint Kitts and Nevis | PM | Saint Pierre and Miquelon | WS | Samoa |
| DJ | Djibouti | KM | Comoros | PR | Puerto Rico | YE | Yemen |
| DK | Denmark | KP | Korea, Democratic People's Republic of | PT | Portugal | YT | Mayotte |
| DM | Dominica | | | PW | Palau | YU | Yugoslavia |
| DO | Dominican Republic | KR | Korea, Republic of | PY | Paraguay | ZA | South Africa |
| DZ | Algeria | KW | Kuwait | QA | Qatar | ZM | Zambia |
| EC | Ecuador | KY | Cayman Islands | RE | Réunion | ZR | Zaire |
| EE | Estonia | KZ | Kazakhstan | RO | Romania | ZW | Zimbabwe |
| EG | Egypt | | | RU | Russian Federation | | |
| EH | Western Sahara | | | | | | |

Tuner operations

IMPORTANT

Before using the remote control for the following operation;

- 1 Set the remote control mode selector to AUDIO.
- 2 Press FM/AM.

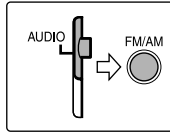

The buttons described below are used on pages 42 to 43.

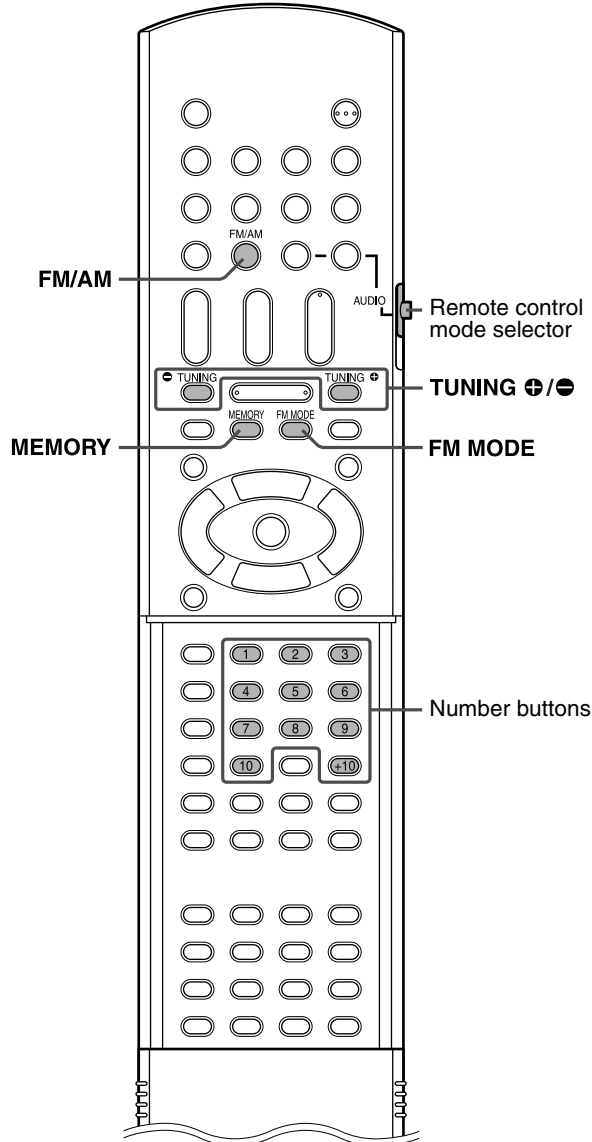

Manual tuning

- 1 Press FM/AM repeatedly to select the band.

Example:

When the system is tuned in to 810 kHz.

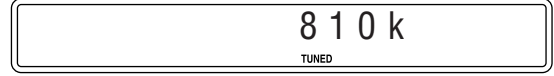

- 2 Press TUNING +/- repeatedly until you find the frequency you want.

When you hold down the button until the system starts searching for stations and then release it, the system stops searching automatically when a station of sufficient signal strength is tuned in to.

NOTE

- When a station of sufficient signal strength is tuned in, the TUNED indicator lights on the display window.
- When an FM stereo program is received, the ST indicator lights on the display window.

Preset tuning

Once a station is assigned to a channel number, the station can be quickly tuned in. You can preset 30 FM and 15 AM stations.

■ To preset the stations

1 Tune in the station you want to preset.

- If you want to store the FM reception mode for an FM station, select the reception mode you want. See “Selecting the FM reception mode” below.

Example:

When the system is tuned in to 103.5 MHz.

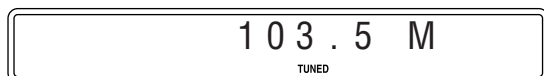

2 Press MEMORY.

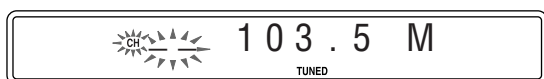

While “CH” and “–” are flashing:

3 Press number button(s) (1-10, +10) to select a preset number you want.

- For details on using the number buttons, see “How to use the number buttons” (pg. 25).

Example:

When the preset channel 1 is selected.

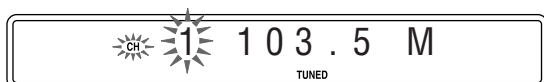

If the setting is cancelled before you finish, start from step 2 again.

While the selected number is flashing:

4 Press MEMORY.

The selected number stops flashing.

The station is assigned to the selected preset number.

If the setting is cancelled before you finish, start from step 2 again.

5 Repeat steps 1 to 4.

- Storing a new station to a used number erases the previously stored one.

■ To tune in to a preset station

1 Press FM/AM repeatedly to select FM or AM.

2 Press number button(s) (1-10, +10) to select a preset number.

- For details on using the number buttons, see “How to use the number buttons” (pg. 25).

Selecting the FM reception mode

When the stereo FM program currently tuned in is noisy, you can change the FM reception mode to improve the reception.

- While listening to an FM station

Press FM MODE.

The FM reception mode appears on the display window.

Each time you press the button, the FM reception mode changes.

- **AUTO MUTING:**
When a program is broadcast in stereo, you will hear stereo sound. (The ST indicator lights on the display window.) When in monaural, you will hear monaural sound. This mode is also useful to suppress static noise between stations. The AUTO MUTING indicator lights on the display window.
- **MONO:**
Reception will be improved although you will lose the stereo effect. (The ST indicator goes off.) In this mode, you will hear noise until you are tuned in to a station. (The AUTO MUTING indicator also goes off.)

Reducing the noise of AM broadcast

When listening to an AM broadcast with a lot of noise interference, you can change the Beat Cut mode to reduce the noise.

- While listening to an AM station

Press FM MODE.

The current Beat Cut mode appears on the display window.

Each time you press the button, the Beat Cut mode changes.

- Choose “BEAT CUT 1” or “BEAT CUT 2” according to which gives clearer sound.

AV COMPU LINK remote control system

The AV COMPU LINK remote control system allows you to operate JVC TVs and VCRs through the center unit. This system is equipped with the AV COMPU LINK-III, which adds a function to operate JVC's video components via the video components terminals. To use this remote control system, you need to connect the video components you want to operate as follows.

AV COMPU LINK

- Refer also to the manuals supplied with your TV and video components.

Connecting a TV and VCR

CAUTION

Before connecting;

- If you have already plugged your VCR, TV and the center unit into the AC outlets, unplug their AC power cords first.

1 Connect the center unit to a TV and VCR.

- For details, see page 14 and 15.

2 Connect the center unit to a TV and VCR using the optional AV COMPU LINK cords.

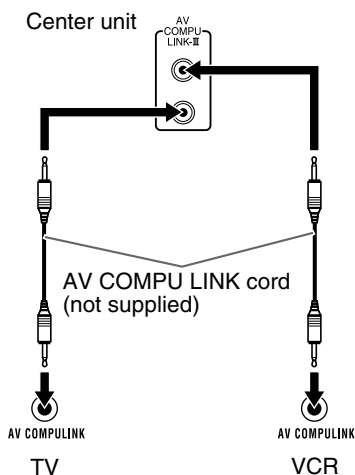

3 Plug the AC power cords of the VCR, TV and the center unit into the AC outlets.

4 Turn on the connected components first, then turn on the center unit.

- When turning on the TV for the first time after the AV COMPU LINK connection, turn the TV volume to minimum using the TV volume control on the TV.
- When turning on the VCR, use the remote control supplied with this system. (Press \odot /VCR/DBS.)

NOTE

- To correctly use the automatic selection of TV input mode, select the correct "M. OUT" setting. (☞ pg. 37)

Available functions

The AV COMPU LINK remote control system allows you to use the functions listed following.

One-touch video play

Simply by inserting a video cassette without its safety tab into the VCR, you can enjoy video playback without manually setting other switches. This system automatically turns on and changes the source to VCR.

The TV automatically turns on and changes the input mode to the appropriate position so that you can view the playback picture. When you insert a video cassette with its safety tab in place, press the play (▶) button on the VCR or on the remote control to get the same result.

One-touch DVD play

Simply by starting playback on the built-in DVD player, you can enjoy playback without manually setting other switches. The TV automatically turns on and changes the input mode to the appropriate position so that you can view the playback picture.

Automatic selection of TV input mode

When you select DVD or VCR as the source to play on the system, the TV automatically changes the input mode to the appropriate position so that you can view the playback picture.

Automatic Power On/Off

The TV and VCR turn on and off along with the system.

When you turn on the system;

- If the previously selected source is "DVD", only the TV will turn on automatically.
- If the previously selected source is "VCR", the TV and VCR will turn on automatically.

When you turn off the system, the TV and VCR will turn off.

NOTE

- If you turn off the system while recording on the VCR, the VCR will not turn off and will continue recording.

Maintenance

■ Handling Discs

- Remove the disc from its case by holding it at the edge while pressing the center hole lightly.
- Do not touch the shiny surface of the disc or bend the disc.
- Put the disc back in its case after use to prevent warping.
- Be careful not to scratch the surface of the disc when placing it back in its case.
- Avoid exposure to direct sunlight, temperature extremes and moisture.



To clean the disc

Wipe the disc with a soft cloth in a straight line from center to edge.

- **DO NOT use any solvent — such as conventional record cleaner, spray, thinner or benzine — to clean the disc.**



■ Cleaning the system

- Stains on the system should be wiped off with a soft cloth. If the system is heavily stained, wipe it with a cloth soaked in water-diluted neutral detergent and wrung well, then wipe clean with a dry cloth.
- Since the system may deteriorate in quality, become damaged or get its paint peeled off, be careful about the following.
 - DO NOT wipe it with a hard cloth.
 - DO NOT wipe it strong.
 - DO NOT wipe it with thinner or benzine.
 - DO NOT apply any volatile substance such as insecticides to it.
 - DO NOT allow any rubber or plastic to remain in contact with it for a long time.

Troubleshooting

| PROBLEM | POSSIBLE CAUSE | SOLUTION |
|---|---|--|
| Power does not come on. | The power cord and/or system cord is not connected. | Connect the power cord and system cord correctly. (☞ pg. 15) |
| The remote control does not work. | The batteries are exhausted. | Replace the batteries. (☞ pg. 7) |
| | Sunlight is falling directly on the remote sensor. | Hide the remote sensor from direct sunlight. |
| No sound. | The system cord and/or speaker cord is not connected. | Check the connection. (☞ pg. 15) |
| | The audio cord is not connected to AUDIO IN (VCR) and/or DIGITAL IN (DBS) correctly. | Connect the cord correctly. (☞ pg. 15) |
| | An incorrect source has been selected. | Select the correct source. (☞ pg. 19) |
| | The decode mode is not set correctly. | Select the proper decode mode. (☞ pg. 37) |
| No picture is displayed on the TV screen. | The video cord is not connected correctly. | Connect the cord correctly. (☞ pg. 14) |
| | The disc is not playable. | Use a playable disc. (☞ pg. 3) |
| No picture is displayed on the TV screen, the picture is blurred, or the picture is divided into two parts. | The scan mode is set to "PROGRESSIVE" though the center unit is connected to the TV which does not support the progressive video input such as a conventional TV. | Change the scan mode to "INTERLACE". (☞ pg. 20) |
| Video and audio are distorted. | The disc is scratched or dirty. | Replace or clean the disc. |
| | A VCR is connected between the center unit and the TV. | Connect the center unit and TV directly. (☞ pg. 14) |
| The picture does not fit the TV screen. | The monitor type is not set correctly. | Set "MONITOR TYPE" properly. (☞ pg. 39) |
| Hard to listen to broadcast because of noise. | Antennas are disconnected. | Reconnect the antennas correctly and securely. (☞ pg. 8) |

Specifications

■ Center unit (XV-THM606/XV-THM603/XV-THM505/XV-THM501/ XV-THM303/XV-THM301)

Audio section

Total Harmonic Distortion 0.02 %

NOTE: This value is measured at System cord CONNECTOR for reference.

Digital input*1:

DIGITAL IN (DBS): -21 dBm to -15 dBm
(OPTICAL) (660 nm ±30 nm)

*1 Corresponding to Linear PCM, Dolby Digital, and DTS Digital Surround (with sampling frequency — 32 kHz, 44.1 kHz, 48 kHz)

Video section

Video System: NTSC
Horizontal Resolution: 500 lines
Signal-to-Noise Ratio: 64 dB

Video output level

Composite: 1.0 V(p-p)/75 Ω
S-video-Y: 1.0 V(p-p)/75 Ω
S-video-C: 0.286 V(p-p)/75 Ω
Component-Y: 1.0 V(p-p)/75 Ω
Component-Pb/Pr: 0.7 V(p-p)/75 Ω

Video input sensitivity/Impedance (VCR IN)

Composite: 1.0 V(p-p)/75 Ω
S-video-Y: 1.0 V(p-p)/75 Ω
S-video-C: 0.286 V(p-p)/75 Ω

Tuner section

Tuning Range
FM: 87.5 MHz to 108.0 MHz
AM: 530 kHz to 1 710 kHz

General

Power Requirements: AC 120 V ~, 60 Hz
Power Consumption: 18 W (at operation)
2.0 W (in standby mode)

Dimensions (W × H × D):
400 mm × 85 mm × 380 mm
(15-3/4 inches × 3-3/8 inches × 15 inches)

Mass: 4.3 kg (9.5 lbs)

■ Subwoofer (SP-PWM606)

Amplifier section

Front/Center/Surround: 140 W per channel, RMS at 4 Ω at 1 kHz, with 10 % total harmonic distortion.

Subwoofer: 300 W, RMS at 4 Ω at 100 Hz, with 10 % total harmonic distortion.

Speaker section

Speaker unit: 25 cm (9-7/8 inches) Bass-reflex, Magnetically Shielded

Frequency Range: 25 Hz to 200 Hz

General

Power Requirements: AC 120 V ~, 60 Hz
Power Consumption: 155 W (at operation)
0 W (in standby mode)

Dimensions (W × H × D):
255 mm × 480 mm × 445 mm
(10-1/16 inches × 18-15/16 inches × 17-9/16 inches)

Mass: 13.0 kg (28.7 lbs)

■ Subwoofer (SP-PWM505/SP-PWM501)

Amplifier section

Front/Center/Surround: 140 W (80 W*2) per channel, RMS at 4 Ω (Center/Surround)/ 140 W (120 W*2) per channel, RMS at 4 Ω (Front) at 1 kHz, with 10 % total harmonic distortion.

Subwoofer: 300 W, RMS at 4 Ω at 100 Hz, with 10 % total harmonic distortion.

Speaker section

Speaker unit: 25 cm (9-7/8 inches) Bass-reflex, Magnetically Shielded

Frequency Range: 20 Hz to 200 Hz

General

Power Requirements: AC 120 V ~, 60 Hz
Power Consumption: 155 W (at operation)
0 W (in standby mode)

Dimensions (W × H × D):
256 mm × 482 mm × 460 mm
(10-1/8 inches × 19 inches × 18-1/8 inches)

Mass: 18.5 kg (41 lbs)

*2For SP-PWM501

■ Subwoofer (SP-PWM603/SP-PWM303/SP-PWM301)

Amplifier section

Front/Center/Surround: 115 W (100 W*3) per channel, RMS at 4 Ω (Center/Surround)/ 125 W (115 W*3) per channel, RMS at 4 Ω (Front) at 1 kHz, with 10 % total harmonic distortion.

Subwoofer: 125 W (120 W*3), RMS at 4 Ω at 100 Hz, with 10 % total harmonic distortion.

Speaker section

Speaker unit: 16 cm (6-5/16 inches) Bass-reflex, Magnetically Shielded

Frequency Range: 30 Hz to 200 Hz

General

Power Requirements: AC 120 V ~, 60 Hz
Power Consumption: 125 W (at operation)
0 W (in standby mode)

Dimensions (W × H × D):
168.5 mm × 412 mm × 444 mm
(6-11/16 inches × 16-1/4 inches × 17-1/2 inches)

Mass: 12.0 kg (26.5 lbs)

*3For SP-PWM301

Continued on next page

References

■ Satellite Speakers

Front speakers (SP-THM606F)

Speakers: 5.5 cm (2-3/16 inches) × 2
3.0 cm (1-3/16 inches)
Bass-reflex, Magnetically Shielded

Power Handling Capacity: 140 W
Impedance: 4 Ω
Frequency Range: 95 Hz to 20 kHz
Dimensions (W × H × D):
250 mm × 1103 mm × 250 mm
(9-7/8 inches × 43-7/16 inches × 9-7/8 inches)

Mass: 3.67 kg (8.1 lbs)

Surround speakers (SP-THM606S)

Speakers: 5.5 cm (2-3/16 inches) × 2
Bass-reflex, Magnetically Shielded

Power Handling Capacity: 140 W
Impedance: 4 Ω
Frequency Range: 90 Hz to 20 kHz
Dimensions (W × H × D):
250 mm × 1103 mm × 250 mm
(9-7/8 inches × 43-7/16 inches × 9-7/8 inches)

Mass: 3.77 kg (8.4 lbs)

Center Speaker (SP-THM606C)

Speakers: 5.5 cm (2-3/16 inches) × 2
3.0 cm (1-3/16 inches)
Bass-reflex, Magnetically Shielded

Power Handling Capacity: 140 W
Impedance: 4 Ω
Frequency Range: 90 Hz to 20 kHz
Dimensions (W × H × D):
209 mm × 85 mm × 92 mm
(8-1/4 inches × 3-3/8 inches × 3-5/8 inches)

Mass: 0.87 kg (2.0 lbs)

■ Satellite Speakers

Front speakers (SP-THM505F)

Speakers: Woofer: 8.0 cm (3-3/16 inches)
Tweeter: 1.5 cm (5/8 inches)
Bass-reflex, Magnetically Shielded

Power Handling Capacity: 140 W
Impedance: 4 Ω
Frequency Range: 90 Hz to 20 kHz
Dimensions (W × H × D):
104.5 mm × 139 mm × 101 mm
(4-1/8 inches × 5-1/2 inches × 4 inches)

Mass: 0.7 kg (1.6 lbs)

Surround speakers (SP-THM505S)

Speakers: 8.0 cm (3-3/16 inches)
Bass-reflex, Magnetically Shielded

Power Handling Capacity: 140 W
Impedance: 4 Ω
Frequency Range: 80 Hz to 20 kHz
Dimensions (W × H × D):
111.5 mm × 139 mm × 106.5 mm
(4-7/16 inches × 5-1/2 inches × 4-1/4 inches)

Mass: 0.52 kg (1.2 lbs)

Center Speaker (SP-THM505C)

Speakers: Woofer: 8.0 cm (3-3/16 inches)
Tweeter: 1.5 cm (5/8 inches)
Bass-reflex, Magnetically Shielded

Power Handling Capacity: 140 W
Impedance: 4 Ω
Frequency Range: 90 Hz to 20 kHz
Dimensions (W × H × D):
137 mm × 105 mm × 104.5 mm
(5-7/16 inches × 4-3/16 inches × 4-1/8 inches)

Mass: 0.7 kg (1.6 lbs)

■ Satellite Speakers

Front speakers (SP-THM303F)

Speakers: 8.0 cm (3-3/16 inches)
Bass-reflex, Magnetically Shielded

Power Handling Capacity: 140 W
Impedance: 4 Ω
Frequency Range: 90 Hz to 20 kHz
Dimensions (W × H × D):
106 mm × 119.5 mm × 102 mm
(4-3/16 inches × 4-3/4 inches × 4-1/16 inches)

Mass: 0.69 kg (1.6 lbs)

Surround speakers (SP-THM303S)

Speakers: 8.0 cm (3-3/16 inches)
Bass-reflex, Magnetically Shielded

Power Handling Capacity: 140 W
Impedance: 4 Ω
Frequency Range: 80 Hz to 20 kHz
Dimensions (W × H × D):
111.5 mm × 139 mm × 106.5 mm
(4-7/16 inches × 5-1/2 inches × 4-1/4 inches)

Mass: 0.63 kg (1.4 lbs)

Center Speaker (SP-THM303C)

Speakers: 8.0 cm (3-3/16 inches)
Bass-reflex, Magnetically Shielded

Power Handling Capacity: 140 W
Impedance: 4 Ω
Frequency Range: 90 Hz to 20 kHz
Dimensions (W × H × D):
106 mm × 119.5 mm × 102 mm
(4-3/16 inches × 4-3/4 inches × 4-1/16 inches)

Mass: 0.69 kg (1.6 lbs)

Designs & specifications are subject to change without notice.



LIMITED WARRANTY

CONSUMER VIDEO 1-90

JVC COMPANY OF AMERICA warrants this product and all parts thereof, except as set forth below ONLY TO THE ORIGINAL PURCHASER AT RETAIL to be FREE FROM DEFECTIVE MATERIALS AND WORKMANSHIP from the date of original retail purchase for the period as shown below. ("The Warranty Period")

| | | | |
|-------|-------------|-------|----------------|
| PARTS | 1 YR | LABOR | 90 DAYS |
|-------|-------------|-------|----------------|

THIS LIMITED WARRANTY IS VALID ONLY IN THE FIFTY (50) UNITED STATES, THE DISTRICT OF COLUMBIA AND IN COMMONWEALTH OF PUERTO RICO.

WHAT WE WILL DO:

If this product is found to be defective, JVC will repair or replace defective parts at no charge to the original owner. Such repair and replacement services shall be rendered by JVC during normal business hours at JVC authorized service centers. Parts used for replacement are warranted only for the remainder of the Warranty Period. All products and parts thereof may be brought to a JVC authorized service center on a carry-in basis except for Television sets having a screen size 25 inches and above which are covered on an in-home basis.

WHAT YOU MUST DO FOR WARRANTY SERVICE:

Return your product to a JVC authorized service center with a copy of your bill of sale. For your nearest JVC authorized service center, please call toll free: (800) 537-5722.

If service is not available locally, box the product carefully, preferably in the original carton, and ship, insured, with a copy of your bill of sale plus a letter of explanation of the problem to the nearest JVC Factory Service Center, the name and location of which will be given to you by the toll-free number.

If you have any questions concerning your JVC Product, please contact our Customer Relations Department.

WHAT IS NOT COVERED:

This limited warranty provided by JVC does not cover:

1. Products which have been subject to abuse, accident, alteration, modification, tampering, negligence, misuse, faulty installation, lack of reasonable care, or if repaired or serviced by anyone other than a service facility authorized by JVC to render such service, or if affixed to any attachment not provided with the products, or if the model number or serial number has been altered, tampered with, defaced or removed;
2. Initial installation and installation and removal for repair;
3. Operational adjustments covered in the Owner's Manual, normal maintenance, video and audio head cleaning;
4. Damage that occurs in shipment, due to act of God, and cosmetic damage;
5. Signal reception problems and failures due to line power surge;
6. Video Pick-up Tubes/CCD Image Sensor, Cartridge, Stylus (Needle) are covered for 90 days from the date of purchase;
7. Accessories;
8. Batteries (except that Rechargeable Batteries are covered for 90 days from the date of purchase);

There are no express warranties except as listed above.

THE DURATION OF ANY IMPLIED WARRANTIES, INCLUDING THE IMPLIED WARRANTY OF MERCHANTABILITY, IS LIMITED TO THE DURATION OF THE EXPRESS WARRANTY HEREIN.

JVC SHALL NOT BE LIABLE FOR THE LOSS OF USE OF THE PRODUCT, INCONVENIENCE, LOSS OR ANY OTHER DAMAGES, WHETHER DIRECT, INCIDENTAL OR CONSEQUENTIAL (INCLUDING, WITHOUT LIMITATION, DAMAGE TO TAPES, RECORDS OR DISCS) RESULTING FROM THE USE OF THIS PRODUCT, OR ARISING OUT OF ANY BREACH OF THIS WARRANTY. ALL EXPRESS AND IMPLIED WARRANTIES, INCLUDING THE WARRANTIES OF MERCHANTABILITY AND FITNESS FOR PARTICULAR PURPOSE, ARE LIMITED TO THE WARRANTY PERIOD SET FORTH ABOVE.

Some states do not allow the exclusion of incidental or consequential damages or limitations on how long an implied warranty lasts, so these limitations or exclusions may not apply to you. This warranty gives you specific legal rights and you may also have other rights which vary from state to state.

JVC COMPANY OF AMERICA 1700 Valley Road
 DIVISION OF JVC AMERICAS CORP. Wayne, NJ 07470

REFURBISHED PRODUCTS CARRY A SEPARATE WARRANTY, THIS WARRANTY DOES NOT APPLY. FOR DETAILS OF REFURBISHED PRODUCT WARRANTY, PLEASE REFER TO THE REFURBISHED PRODUCT WARRANTY INFORMATION PACKAGED WITH EACH REFURBISHED PRODUCT.

For customer use:

Enter below the Model No. which is located either on the rear, bottom or side of the cabinet. Retain this information for future reference.

Model No. : _____ Serial No. : _____

Purchase data : _____ Name of dealer : _____

For the U.S.A.

TH-M606/TH-M603/
TH-M505/TH-M501/
TH-M303/TH-M301

DVD DIGITAL THEATER SYSTEM

Authorized Service Centers

QUALITY **JVC**[®] SERVICE

HOW TO LOCATE YOUR JVC SERVICE CENTER

TOLL FREE: 1 (800) 537-5722

<http://www.jvc.com>

Dear Customer,

In order to receive the most satisfaction from your purchase, please read the instruction booklet before operating the unit. In the event that repairs are necessary, please call 1 (800) 537-5722 for your nearest authorized servicer or visit our website at www.JVC.com

Remember to retain your Bill of Sale for Warranty Service.

Do not service the television yourself

Caution

To prevent electrical shock, do not open the cabinet. There are no user serviceable parts inside. Please refer to qualified service personnel for repairs.

Accessories

To purchase accessories for your JVC product, please call toll free: 1 (800)882-2345 or on the web at www.JVC.com

JVC
VICTOR COMPANY OF JAPAN, LIMITED

